



Carbon Steel Ball Valves Series 500CS/502CS

MATERIALS OF CONSTRUCTION	
VALVE BODY:	CARBON STEEL PHOSPHATE COATED
BALL:	STEEL
SEATS / SEALS:	PTFE
HANDLE:	STEEL

STYLE	TYPE	MATERIAL	SIZE	OPTIONS
V	500	CS	-4	-00
STYLE	<ul style="list-style-type: none"> V-VALVE VP-VALVE, PADLOCKING HANDLE 			
TYPE	500 FEMALE/FEMALE PTF PORTS			
MATERIAL	CS-CRARBON STEEL			
SIZE	4-1/4", 6-3/8", 8-1/2", 12-3/4", 16-1", 20-1 1/4", 24-1 1/2", 32-2"			
OPTIONS	<ul style="list-style-type: none"> 04-TEE HANDLE 21-OVAL HANDLE 			

SPECIFICATIONS	
PRESSURE RANGE:	<ul style="list-style-type: none"> 2,000 PSI SIZES: 1/4" – 1" 1,500 PSI SOZES: 1 1/4" – 2" SATURATED STEAM UP TO 150 PSI
TEMPERATURE RANGES:	0° TO +425°F
OPERATING INSTRUCTIONS	QUARTER TURN IS "ON" OR "OFF". (PROVIDES POSITIVE STOP ACTION FOR FULL SHUTOFF.)
NOTE:	PERIODICALLY CHECK THE ADJUSTABLE PACKING NUT AND TIGHTEN AS REQUIRED.

FLOW DATA	
VALVE SIZE	CV
1/4	6.0
3/8	12.8
1/2	15.0
3/4	23.0
1	36.0
1-1/4	44.0
1-1/2	64.0
2	114.0



Parker's industrial ball valve product line is intended for general purpose use. Please be aware that ball valves are intended for use in the fully open or closed positions. Depending on application conditions, throttling of the valve may result in premature seal failure and/or inability to turn the valve handle.

For use as fuel line shutoffs for gasoline and diesel powered over the highway, off highway, and construction equipment vehicles. Hydraulic and general industrial applications on capital equipment and plant design plumbing that require total shutoff capability.

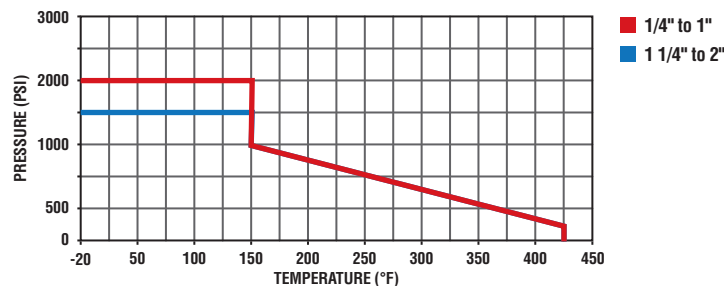

K

Female-Female Pipe Ends XV500CS

PART NO.	PIPE THREAD	B HEX	C HEX	H	L	M	N	D FLOW Ø
XV500CS-4	1/4	1-1/16	15/16	3.78	1.00	2.00	1.63	.400
XV500CS-6	3/8	1-1/16	15/16	3.78	1.00	2.00	1.63	.400
XV500CS-8	1/2	1-1/4	1-1/16	3.78	1.25	2.37	1.73	.540
XV500CS-12	3/4	1-5/8	1-3/8	5.10	1.50	2.90	2.08	.680
XV500CS-16	1	2	1-5/8	5.10	1.76	3.41	2.30	.880

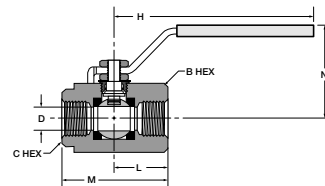

Female-Female Pipe Ends, Panel Mount XV502CS

PART NO.	PIPE THD	B HEX	C HEX	F	G	H	L	M	N	FLOW DIA. D
XV502CS-20	1-1/4	2	2-1/4	.94	1.50	6.10	1.87	3.80	2.76	1.000
XV502CS-24	1-1/2	2-5/16	2-1/2	.94	1.50	6.10	2.27	4.55	2.98	1.250
XV502CS-32	2	2-3/4	3	1.03	2.00	8.60	2.42	4.83	3.54	1.500

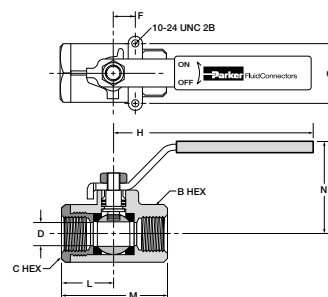

Locking Handle, Female Pipe Ends XVP500CS

PART NO.	PIPE THD	B HEX	C HEX	H	L	M	N	D FLOW Ø
XVP500CS-4	1/4	1-1/16	15/16	4.13	1.00	2.00	2.23	.400
XVP500CS-6	3/8	1-1/16	15/16	4.13	1.00	2.00	2.23	.400
XVP500CS-8	1/2	1-1/4	1-1/16	4.13	1.25	2.37	2.33	.540
XVP500CS-12	3/4	1-5/8	1-3/8	5.00	1.50	2.90	2.80	.680
XVP500CS-16	1	2	1-5/8	5.00	1.76	3.41	2.97	.880

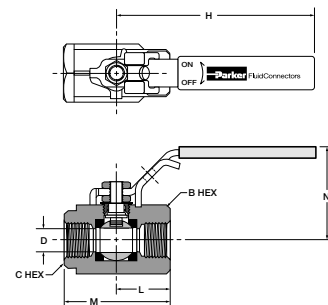

Locking Handle, Female Pipe Ends, Panel Mount XVP502CS

PART NO.	PIPE THD	B HEX	C HEX	F	G	H	L	M	N	FLOW DIA. D
XVP502CS-20	1-1/4	2	2-1/4	.94	1.50	7.50	1.87	3.80	3.15	1.000
XVP502CS-24	1-1/2	2-5/16	2-1/2	.94	1.50	7.50	2.27	4.55	3.37	1.250
XVP502CS-32	2	2-3/4	3	1.03	2.00	8.75	2.42	4.83	3.46	1.500

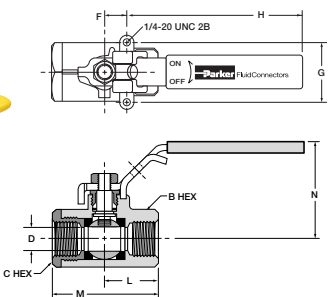

Tee Handle, Female Pipe Ends XV500CS-X-04

PART NO.	PIPE THD	B HEX	C HEX	H	L	M	N	D FLOW Ø
XV500CS-4-04	1/4	1-1/16	15/16	2.16	1.08	2.00	1.41	.400
XV500CS-6-04	3/8	1-1/16	15/16	2.16	1.08	2.00	1.41	.400
XV500CS-8-04	1/2	1-1/4	1-1/16	2.90	1.45	2.37	1.66	.540
XV500CS-12-04	3/4	1-5/8	1-3/8	3.63	1.81	2.90	2.06	.680
XV500CS-16-04	1	2	1-5/8	3.63	1.81	3.41	2.23	.880

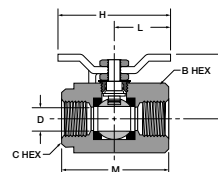

Oval Handle, Female Pipe Ends XV500CS-X-21

PART NO.	PIPE THD	B HEX	C HEX	H	L	M	N	D FLOW Ø
XV500CS-4-21	1/4	1-1/16	15/16	3.50	1.00	2.00	1.66	.400
XV500CS-6-21	3/8	1-1/16	15/16	3.50	1.00	2.00	1.66	.400
XV500CS-8-21	1/2	1-1/4	1-1/16	3.50	1.13	2.37	1.76	.540
XV500CS-12-21	3/4	1-5/8	1-3/8	5.00	1.46	2.90	2.13	.680
XV500CS-16-21	1	2	1-5/8	5.00	1.58	3.41	2.29	.880

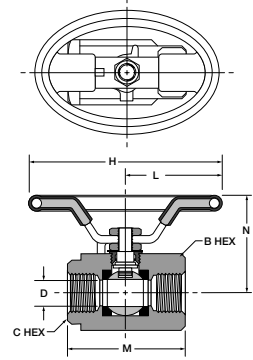

Oval Handle, Female Pipe Ends, Panel Mount XV502CS-X-21

PART NO.	PIPE THD	B HEX	C HEX	F	G	H	L	M	N	FLOW DIA. D
XV502CS-20-21	1-1/4	2	2-1/4	.94	1.50	5.07	2.53	3.80	3.04	1.000
XV502CS-24-21	1-1/2	2-5/16	2-1/2	.94	1.50	5.07	2.53	4.55	3.26	1.250
XV502CS-32-21	2	2-3/4	3	1.03	2.00	6.50	3.25	4.83	3.57	1.500

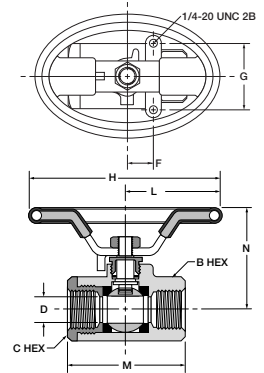



Carbon Steel Ball Valves Series 506CS

MATERIALS OF CONSTRUCTION	
VALVE BODY:	CARBON STEEL PHOSPHATE COATED
BALL:	STEEL
SEATS / SEALS:	PTFE
HANDLE:	STEEL

STYLE	TYPE	MATERIAL	SIZE	OPTIONS
V	506	CS	-4	-00
STYLE	<ul style="list-style-type: none"> V-VALVE VP-VALVE, PADLOCKING HANDLE 			
TYPE	506-FEMALE/FEMALE SAE STRAIGHT THREAD PORTS			
MATERIAL	CS-CARBON STEEL			
SIZE	4-1/4", 6-3/8", 8-1/2", 12-3/4", 16-1"			

SPECIFICATIONS	
PRESSURE RANGE:	<ul style="list-style-type: none"> 3,000 PSI SATURATED STEAM UP TO 150 PSI
TEMPERATURE RANGES:	0° TO +425°F
OPERATING INSTRUCTIONS	QUARTER TURN IS "ON" OR "OFF". (PROVIDES POSITIVE STOP ACTION FOR FULL SHUTOFF.)

FLOW DATA	
VALVE SIZE	CV
1/4	6.0
3/8	12.0
1/2	15.0
3/4	34.0
1	54.0



Parker's industrial ball valve product line is intended for general purpose use. Please be aware that ball valves are intended for use in the fully open or closed positions. Depending on application conditions, throttling of the valve may result in premature seal failure and/or inability to turn the valve handle.

For use as fuel line shutoffs for gasoline and diesel powered over the highway, off highway, and construction equipment vehicles. Hydraulic and general industrial applications on capital equipment and plant design plumbing that require total shutoff capability.

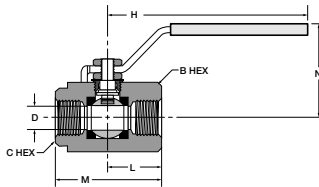

Female-Female SAE Straight Thread Ports XV506CS

PART NO.	STRAIGHT THREAD	B HEX	C HEX	H	L	M	N	D FLOW Ø
XV506CS-4	7/16-20	1-1/16	15/16	3.78	1.00	2.00	1.63	.400
XV506CS-6	9/16-18	1-1/16	15/16	3.78	1.00	2.00	1.63	.400
XV506CS-8	3/4-16	1-5/8	1-1/4	4.78	1.32	2.84	2.16	.500
XV506CS-12	1-1/16-12	1-7/8	1-5/8	4.78	1.66	3.71	2.35	.750
XV506CS-16	1-5/16-12	2-1/2	2-1/8	6.10	1.88	4.15	2.85	1.000

