



# Compression Style Pneumatic



## Compression

- Economical
- UL Listed
- Thermoplastic / Soft Metal Tubing



## Compress-Align®

- Captive Sleeve
- Two piece
- Pre-assembled



## Parker Metru-Lok™

- Captive Sleeve
- Metric Tubing
- NPT, BSPT, BSPP, Metric Threads



## Poly-Tite

- Built-in Tube Support
- Captive Sleeve
- Knurled Nut











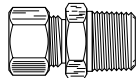
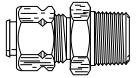
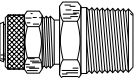
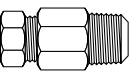
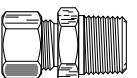
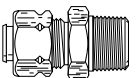
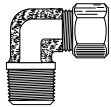
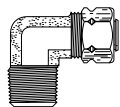
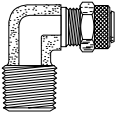

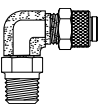
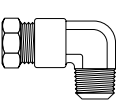
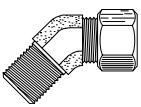
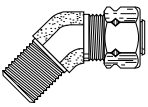
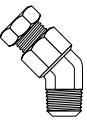
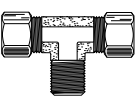
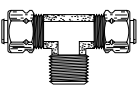
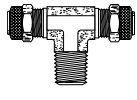
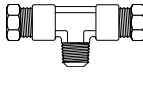
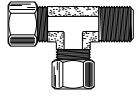
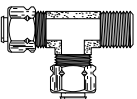
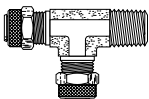
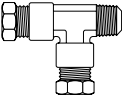

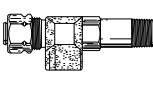
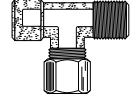
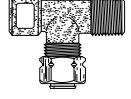
## Hi-Duty

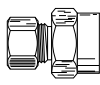
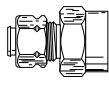
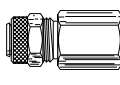
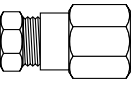
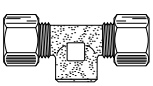
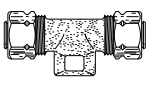
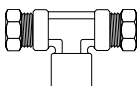

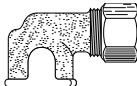
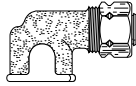
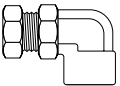
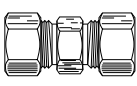

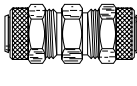
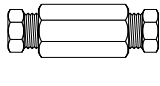
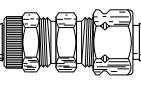
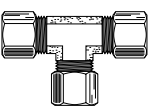
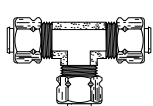

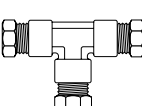
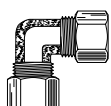
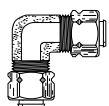
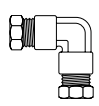



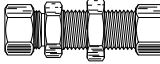
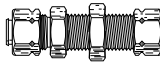
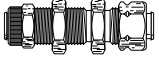

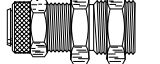

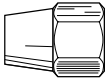

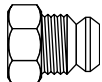







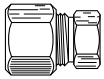

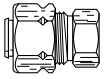
- Two Piece Design
- Easy Assembly
- Higher Pressure Rating

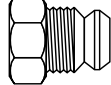
***The World Standard***

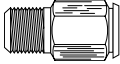
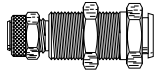



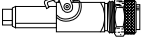
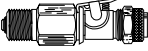
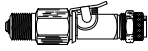





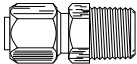
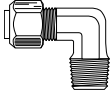
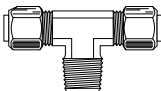
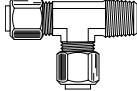
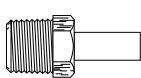
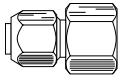
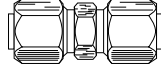
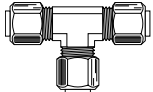

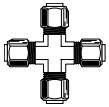

**A**

<b>Tube to Male NPTF</b>	<b>68C</b> Male Connector  Page A8	<b>68CA</b> Male Connector  Page A16	<b>68P</b> Male Connector  Page A34	<b>68HD</b> Male Connector  Page A44	<b>682C</b> Tank Fitting  Page A12	<b>682CA</b> Tank Fitting  Page A19	
	<b>169C-269C</b> Male Elbow  Page A10	<b>169CA-269CA</b> Male Elbow  Page A17	<b>169P/269P</b> Male Elbow  Page A39	<b>169LP</b> Long Elbow  Page A39	<b>169PS</b> Male Elbow  Page A39	<b>169HD</b> Male Elbow  Page A44	<b>179C</b> 45° Male Elbow  Page A11
	<b>179CA</b> 45° Male Elbow  Page A19	<b>179HD</b> 45° Male Elbow  Page A45	<b>172C</b> Male Branch Tee  Page A11	<b>172CA</b> Male Branch Tee  Page A18	<b>172P</b> Male Branch Tee  Page A40	<b>172HD</b> Male Branch Tee  Page A45	<b>171C</b> Male Run Tee  Page A10
	<b>171CA</b> Male Run Tee  Page A18	<b>171P</b> Male Run Tee  Page A40	<b>171HD</b> Male Run Tee  Page A45	<b>168C</b> Gauge Tee  Page A9	<b>168CA</b> Gauge Tee  Page A17	<b>176C</b> Adaptor  Page A11	<b>176CA</b> Adaptor  Page A18
	<b>NV311P</b> Needle Valve  Page A41	<b>NV312P</b> Needle Valve  Page A41	<b>Tube to Female NPT</b>	<b>66C</b> Female Connector  Page A8	<b>66CA</b> Female Connector  Page A15	<b>66P</b> Female Connector  Page A33	<b>66HD</b> Female Connector  Page A44
	<b>177C</b> Female Tee  Page A11	<b>177CA</b> Female Tee  Page A18		<b>177HD</b> Female Tee  Page A46	<b>177P</b> Female Tee  Page A40	<b>170C-270C</b> Female Elbow  Page A10	<b>170CA-270CA</b> Female Elbow  Page A18
	<b>170HD</b> Female Elbow  Page A45	<b>Tube to Tube</b>	<b>62C</b> Union  Page A7	<b>62CA</b> Union  Page A14	<b>62P</b> Union  Page A32	<b>62HD</b> Union  Page A43 & 44	<b>62PCA</b> Union  Page A15, A32
<b>164C-264C</b> Union Tee  Page A9	<b>164CA-264CA</b> Union Tee  Page A16		<b>164P</b> Union Tee  Page A38	<b>164HD</b> Union Tee  Page A43	<b>165C-265C</b> Union Elbow  Page A9	<b>165CA-265CA</b> Union Elbow  Page A17	<b>165HD</b> Union Elbow  Page A43

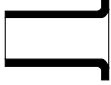
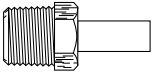
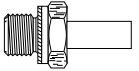
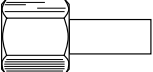
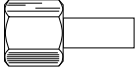
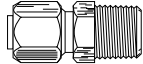
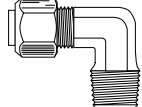
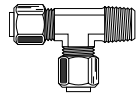
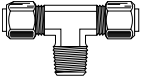

<b>Bulkhead Unions</b>	<b>62CBH</b> Bulkhead Union  Page A7	<b>62CABH</b> Bulkhead Union  Page A14	<b>62PCABH</b> Bulkhead Union  Page A15, A33	<b>62HDBH</b> Bulkhead Union  Page A43	<b>62PBH</b> Bulkhead Union  Page A32	<b>62PTBH</b> Bulkhead Union  Page A33
	<b>Auxiliary Components</b>	<b>61C</b> Nut  Page A6	<b>61CL</b> Long Nut  Page A6	<b>61CA</b> Nut/Sleeve  Page A14	<b>61HD</b> Nut/Sleeve  Page A43	<b>61P</b> Nut/Plastic Sleeve  Page A31
<b>61PN</b> Nut Only  Page A31		<b>60C</b> Sleeve  Page A6	<b>60PT</b> Plastic Sleeve  Page A6	<b>60P</b> Plastic Sleeve  Page A31	<b>60PB</b> Brass Sleeve  Page A31	<b>61PSGN</b> Spring Gaurd Nut  Page A32
<b>639C</b> Seal Plug  Page A12	<b>59CA</b> Plug  Page A14	<b>639CA</b> Seal Plug  Page A19	<b>56PSG</b> Spring Gaurd  Page A31	<b>59HD</b> Plug  Page A46	<b>59P</b> Plug  Page A31	
<b>Couplers</b>	<b>391P &amp; 391PSS</b> Coupler Body  Page A34	<b>392P &amp; 392PSS</b> Bulkhead Body  Page A35	<b>393P &amp; 393PSS</b> Through Insert  Page A35	<b>393PD &amp; 393PDSS</b> Shutoff Insert  Page A35, A36	<b>394P &amp; 394PSS</b> Single Shutoff  Page A36	<b>394PD &amp; 394PDSS</b> Double Shutoff  Page A36, A37
	<b>398P &amp; 398PSS</b> Single Shutoff  Page A37	<b>398PD &amp; 398PDSS</b> Double Shutoff  Page A38	<b>Tube Stub</b>	<b>97P</b> Tube End Reducer  Page A34		

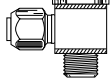
**A**

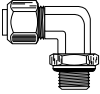
<b>Metric Tube to Male NPTF</b>	<b>FBMB</b> Male Connector  Page A21	<b>CBMB</b> Male Elbow  Page A23	<b>SBMB</b> Male Branch Tee  Page A25	<b>RBMB</b> Male Run Tee  Page A24	<b>T2HFB</b> Tube End Adaptor  Page A26		
	<b>GBMB</b> Female Connector  Page A22	<b>Metric Tube to Metric Tube</b>	<b>HBMB</b> Union  Page A22	<b>JBMB</b> Union Tee  Page A24	<b>EBMB</b> Union Elbow  Page A24	<b>KBMB</b> Union Cross  Page A25	
	<b>WBMB</b> Bulkhead Union  Page A22	<b>WBMPB</b> Bulkhead Union  Page A23	<b>Metric Auxiliary Components</b>	<b>BMB</b> Nut  Page A27	<b>BTMB</b> Nut/Sleeve  Page A28	<b>TMB</b> Sleeve  Page A28	
<b>FNMB</b> Cap  Page A28	<b>PNMB</b> Plug  Page A28	<b>TRBMB</b> Tube End Reducer  Page A29	<b>T23UB</b> Tube Support  Page A29	<b>Metric Tube Stubs</b>	<b>T23HFB</b> Tube Stub/BSPT  Page A26	<b>T28HFB</b> Tube Stub Metric Straight Thread  Page A26	
<b>T2HGB</b> Female Tube Stub  Page A27	<b>T24HGB</b> Female BSPP  Page A27	<b>Metric Tube to BSPT</b>	<b>F3BMB</b> Male Connector  Page A21	<b>C3BMB</b> Male Elbow  Page A23	<b>R3BMB</b> Male Run Tee  Page A24	<b>S3BMB</b> Male Branch Tee  Page A25	
<b>Metric Tube to BSPP</b>	<b>F4BMB</b> Male Connector  Page A21	<b>G4BMB</b> Female Connector  Page A22	<b>COR4BMB</b> Single Banjo  Page A25	<b>Metric Tube to Metric Straight Thread</b>	<b>F8BMB</b> Male Connector  Page A21	<b>C8BMB</b> Male Elbow  Page A23	

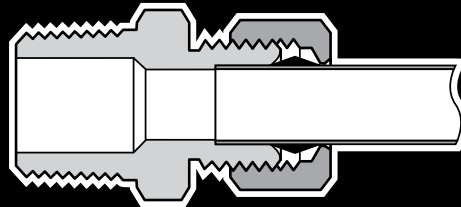

## Compression Fittings

### Advantages

No flaring, soldering or other preparation of tubing necessary to assemble. This economical fitting is readily available in a broad selection of styles. Manufactured from CA 360, CA 345 or CA 377 brass.

### Specifications

Listed with Underwriter's Laboratories for flammable liquid. Compression fittings meet functional requirements of SAE J-512. Refer to list of UL listed fittings on page M10 for specific configurations.

### Applications

Use with annealed copper, aluminum, and Parflex thermoplastic tubing. Not recommended for steel tubing. Manufactured for low and medium pressure tubing connection work where excessive vibration or tube movement is not involved.

### Working Pressure Ranges

Temperature and type of tubing used are important factors. However, the following table is a good guide for proper selection. Temperature 73°F. For thermoplastic tubing, see manufacturers recommendation for pressure range.

PSI	Tube O.D. (Inches)	Tube Wall (Inches)
400	1/8	.030
400	3/16	.030
300	1/4	.030
300	5/16	.032
200	3/8	.032
200	1/2	.032
150	5/8	.035
100	3/4	.035
75	7/8	.035

### Temperature Ranges

From -65° to +250°F with soft metal tubing. For thermoplastic tubing, see manufacturers recommendation for tubing temperature range.

### Vibration

Fair resistance to vibration or tube movement, depending on applications involved. Use long nut for additional resistance to vibration.

### Assembly Instructions

1. Slide nut, then sleeve onto tubing. The thread end of the nut must face out.
2. Insert the tube into the fitting. Be sure the tube is bottomed on the fitting shoulder.
3. Assemble nut to body, and tighten "hand-tight". Then follow the number of wrench turns as indicated in the following table.

### Order

By part number and name.

Fitting Size	Tube Size	Turns required to seal from hand-tight	
		60C with soft metal tubing	60PT with thermoplastic tubing
2	1/8	1-1/4	—
3	3/16	1-1/4	—
4	1/4	1-1/4	2
5	5/16	1-1/4	2
6	3/8	2-1/4	2
8	1/2	2-1/4	2
10	5/8	2-1/4	2
12	3/4	2-1/4	2
14	7/8	2-1/4	—

### Nomenclature

Part numbers are constructed from symbols that identify the style and size of the fitting. The first series of numbers and letters identifies the style and type fitting. The second series of numbers describes the size.

#### Example:

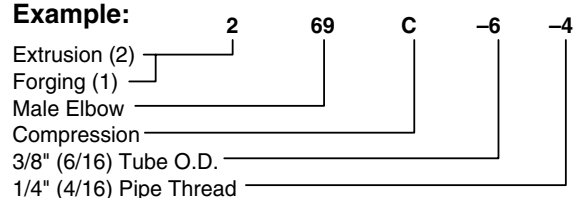

Note: To order compression assemblies with long nuts, add the letter "L" after the letter "C". Example: 62C-4 with short nut, 62CL-4 with long nut

### Sizes

Tube sizes are determined by the numbers of sixteenths of an inch in the tube O.D.

### Special Fittings

Fitting configurations and/or sizes other than those shown in the catalog can be furnished. It is suggested that a print or sketch be submitted with the inquiry. Special UL stamped fittings are available. Please consult price list.

### Pricing

Only items priced in current supplementary price list PL3501 are carried in stock. Price and delivery for non-stock items furnished on request for specified quantity.

**A**

**Sleeve 60C**

Ref. SAE 060115

PART NO.	TUBE SIZE	A	D	L
60C-2	1/8	.187	.130	.19
60C-3	3/16	.266	.192	.22
60C-4	1/4	.344	.255	.25
60C-5	5/16	.406	.318	.25
60C-6	3/8	.469	.382	.25
60C-7	7/16	.531	.444	.31
60C-8	1/2	.594	.507	.38
60C-10	5/8	.719	.632	.38
60C-12	3/4	.875	.758	.44
60C-14	7/8	1.000	.883	.41

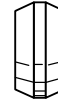
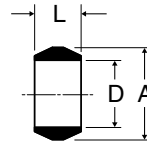

**Delrin Sleeve 60PT**

PART NO.	PLASTIC TUBE WALL	TUBE WALL	A	D	L
60PT-4	1/4	.040	.375	.254	.19
60PT-5	5/16	.062	.438	.317	.19
60PT-6	3/8	.062	.500	.379	.19
60PT-8	1/2	.062	.631	.507	.25
60PT-10	5/8	.062	.747	.632	.22
60PT-12	3/4	.062	.931	.760	.25

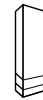
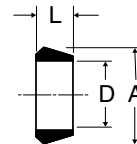

**Nut 61C**

Ref. SAE 060110

PART NO.	TUBE SIZE	STRAIGHT THREAD	C HEX	D	L
61C-2	1/8	5/16-24	3/8	.130	.38
61C-3	3/16	3/8-24	7/16	.192	.41
61C-4	1/4	7/16-24	1/2	.255	.44
61C-5	5/16	1/2-24	9/16	.318	.44
61C-6	3/8	9/16-24	5/8	.382	.47
61C-7	7/16	5/8-24	11/16	.444	.50
61C-8	1/2	11/16-20	13/16	.507	.62
61C-10	5/8	13/16-18	15/16	.632	.62
61C-12	3/4	1-18	1-3/16	.758	.69
61C-14	7/8	1-1/8-18	1-1/4	.890	.62

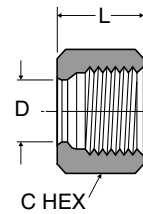

**Long Nut 61CL**

Ref. SAE 060111

PART NO.	TUBE SIZE	STRAIGHT THREAD	C HEX	D	L
61CL-4	1/4	7/16-24	1/2	.255	.75
61CL-5	5/16	1/2-24	9/16	.318	.84
61CL-6	3/8	9/16-24	5/8	.382	.97
61CL-8	1/2	11/16-20	13/16	.507	1.06
61CL-10	5/8	13/16-18	15/16	.632	1.19
61CL-12	3/4	1-18	1-3/16	.758	1.38

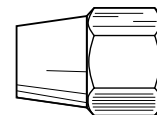
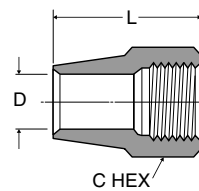



**Union 62C**

Ref. SAE 060101 BA

PART NO.	TUBE SIZE	STRAIGHT THREAD	C HEX	L	M	FLOW DIA. D
62C-2	1/8	5/16-24	5/16	1.05	.64	.094
62C-3	3/16	3/8-24	3/8	1.21	.72	.125
62C-4	1/4	7/16-24	7/16	1.33	.79	.188
62C-5	5/16	1/2-24	1/2	1.39	.85	.250
62C-6	3/8	9/16-24	9/16	1.52	.97	.312
62C-7	7/16	5/8-24	5/8	1.70	1.02	.312
62C-8	1/2	11/16-20	11/16	1.90	1.08	.406
62C-10	5/8	13/16-18	13/16	2.06	1.23	.500
62C-12	3/4	1-18	1	2.37	1.41	.562
62C-14	7/8	1-1/8-18	1-1/8	2.07	1.19	.766

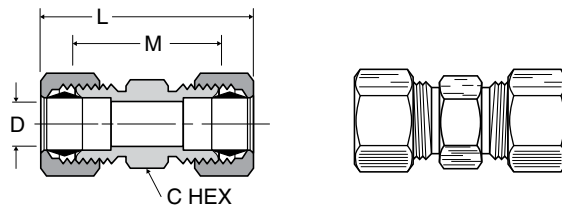

**Union Reducers 62C**

Ref. SAE 060101 BA

PART NO.	1 TUBE SIZE	2 TUBE SIZE	1 STRAIGHT THREAD	2 STRAIGHT THREAD	C HEX	L	M	FLOW DIA. D
62C-4-3	3/16	1/4	3/8-24	7/16-24	7/16	1.29	.78	.125
62C-6-4	1/4	3/8	7/16-24	9/16-24	9/16	1.46	.91	.188
62C-8-6	3/8	1/2	9/16-24	11/16-20	11/16	1.71	1.03	.312
62C-10-6	3/8	5/8	9/16-24	13/16-18	13/16	1.82	1.13	.312

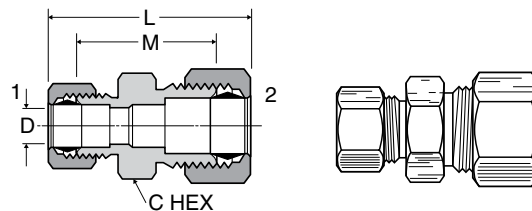

**Bulkhead Union 62CBH**

PART NO.	TUBE SIZE	STRAIGHT THREAD	C HEX	L	M	BULKHEAD HOLE DIA.	FLOW DIA. D
62CBH-4	1/4	7/16-24	9/16	2.29	1.75	7/16	.188
62CBH-6	3/8	9/16-24	11/16	2.42	1.88	9/16	.312

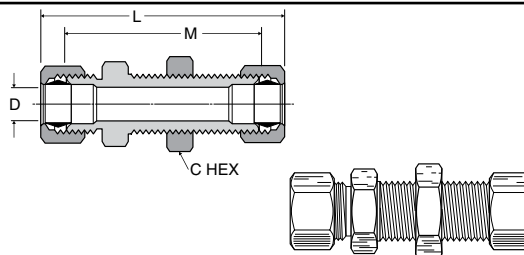

**Brass Insert 63PT**

(For industrial grade plastic tubing)

PART NO.	TUBE O.D.	TUBE WALL	L	O.D.
63PT-2-16	1/8	.016	.46	.080
63PT-2-23	1/8	.023	.45	.073
63PT-2-32	1/8	.032	.31	.061
63PT-3-25	3/16	.025	.45	.135
63PT-3-40	3/16	.040	.52	.095
63PT-4-40	1/4	.040	.50	.163
63PT-4-62	1/4	.062	.33	.110
63PT-5-40	5/16	.040	.50	.232
63PT-5-62	5/16	.062	.53	.187
63PT-6-62	3/8	.062	.56	.250
63PT-8-62	1/2	.062	.72	.370
63PT-10-62	5/8	.062	.72	.483

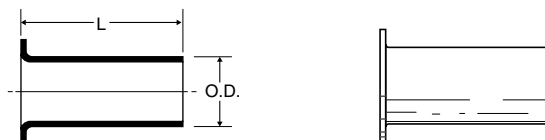

For plastic tubing

Derlin Sleeve 60PT and Brass Insert 63PT converts standard compression fittings for use with industrial grades of thermoplastic tubing.

**A**

**Female Connector 66C**

Ref. SAE 060103 BA

PART NO.	TUBE SIZE	PIPE THREAD	STRAIGHT THREAD	C HEX	L	M	FLOW DIA. D
66C-2-2	1/8	1/8	5/16-24	9/16	.95	.75	.094
66C-3-2	3/16	1/8	3/8-24	9/16	1.02	.78	.125
66C-3-4	3/16	1/4	3/8-24	11/16	1.20	.96	.125
66C-4-2	1/4	1/8	7/16-24	9/16	1.02	.78	.188
66C-4-4	1/4	1/4	7/16-24	11/16	1.24	1.00	.188
66C-5-2	5/16	1/8	1/2-24	9/16	1.07	.81	.250
66C-5-4	5/16	1/4	1/2-24	11/16	1.29	1.03	.250
66C-6-2	3/8	1/8	9/16-24	9/16	1.06	.78	.312
66C-6-4	3/8	1/4	9/16-24	11/16	1.34	1.06	.312
66C-6-6	3/8	3/8	9/16-24	13/16	1.34	1.06	.312
66C-6-8	3/8	1/2	9/16-24	1	1.54	1.27	.312
66C-7-6	7/16	3/8	5/8-24	13/16	1.43	1.09	.312
66C-8-4	1/2	1/4	11/16-20	11/16	1.49	1.09	.406
66C-8-6	1/2	3/8	11/16-20	13/16	1.52	1.12	.406
66C-8-8	1/2	1/2	11/16-20	1	1.71	1.31	.406
66C-10-8	5/8	1/2	13/16-18	1	1.80	1.38	.500

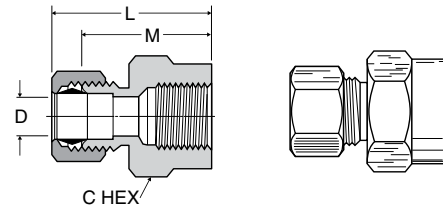

**Male Connector 68C**

Ref. SAE 060102 BA

PART NO.	TUBE SIZE	PIPE THREAD	STRAIGHT THREAD	C HEX	L	M	FLOW DIA. D
68C-2-1	1/8	1/16	5/16-24	11/32	.99	.78	.095
68C-2-2	1/8	1/8	5/16-24	7/16	.97	.77	.094
68C-3-1	3/16	1/16	3/8-24	3/8	1.08	.84	.125
68C-3-2	3/16	1/8	3/8-24	7/16	1.08	.84	.125
68C-3-4	3/16	1/4	3/8-24	9/16	1.27	1.03	.125
68C-4-2	1/4	1/8	7/16-24	7/16	1.10	.86	.188
68C-4-4	1/4	1/4	7/16-24	9/16	1.30	1.06	.188
68C-4-6	1/4	3/8	7/16-24	11/16	1.27	1.03	.188
68C-4-8	1/4	1/2	7/16-24	7/8	1.55	1.31	.188
68C-5-2	5/16	1/8	1/2-24	1/2	1.15	.89	.234
68C-5-4	5/16	1/4	1/2-24	9/16	1.33	1.07	.250
68C-6-2	3/8	1/8	9/16-24	9/16	1.25	.97	.250
68C-6-4	3/8	1/4	9/16-24	9/16	1.42	1.14	.312
68C-6-6	3/8	3/8	9/16-24	11/16	1.44	1.16	.312
68C-6-8	3/8	1/2	9/16-24	7/8	1.53	1.25	.312
68C-7-4	7/16	1/4	5/8-24	5/8	1.50	1.17	.312
68C-8-4	1/2	1/4	11/16-20	11/16	1.60	1.20	.406
68C-8-6	1/2	3/8	11/16-20	11/16	1.60	1.20	.406
68C-8-8	1/2	1/2	11/16-20	7/8	1.71	1.31	.406
68C-10-6	5/8	3/8	13/16-18	13/16	1.73	1.31	.406
68C-10-8	5/8	1/2	13/16-18	7/8	1.90	1.48	.500
68C-10-12	5/8	3/4	13/16-18	1-1/16	1.98	1.56	.500
68C-12-8	3/4	1/2	1-18	1	2.05	1.60	.562
68C-12-12	3/4	3/4	1-18	1-1/16	2.08	1.63	.656
68C-14-12	7/8	3/4	1-1/8-18	1-1/8	1.76	1.41	.750

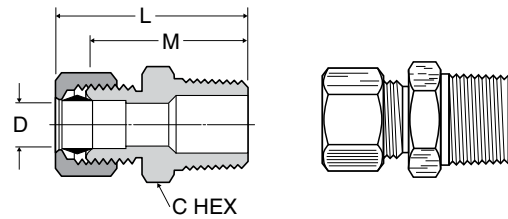





**Union Tee 164C-264C**

Ref. SAE 060401 BA

PART NO.	TUBE SIZE	STRAIGHT THREAD	L	M	FLOW DIA. D
164C-2	1/8	5/16-24	.82	.61	.094
264C-3	3/16	3/8-24	.84	.60	.125
164C-4	1/4	7/16-24	.86	.61	.188
264C-4	1/4	7/16-24	.84	.60	.188
164C-5	5/16	1/2-24	.98	.71	.250
164C-6	3/8	9/16-24	1.03	.74	.312
164C-8	1/2	11/16-20	1.34	.93	.406
164C-10	5/8	13/16-18	1.54	1.08	.500
164C-12	3/4	1.00-18	1.65	1.17	.560

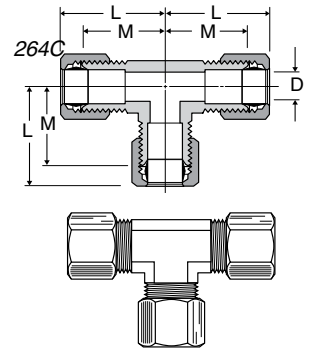
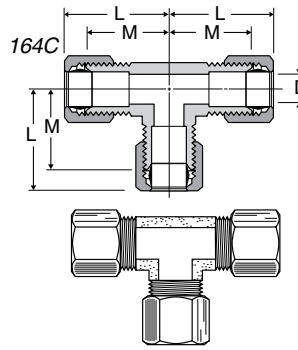

**Union Tee 164C-264C Combination Sizes**

Ref. SAE 060401 BA

PART NO.	1 TUBE SIZE	2 TUBE SIZE	3 TUBE SIZE	L1	L2	L3	M1	M2	M3	FLOW DIA. D
164C-6-4-4	3/8	1/4	1/4	1.03	.96	.96	.75	.72	.72	.188
164C-6-6-4	3/8	3/8	1/4	1.03	.96	.96	.75	.75	.72	.188
164C-8-8-6	1/2	1/2	3/8	1.34	1.16	1.16	.94	.94	.88	.312

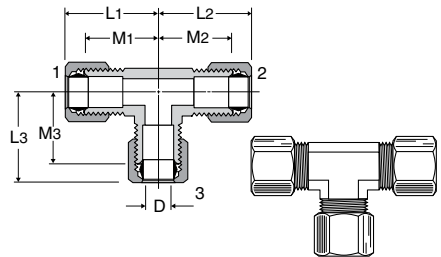

**Union Elbow 165C-265C**

Ref. SAE 060201 BA

PART NO.	TUBE SIZE	STRAIGHT THREAD	L	M	FLOW DIA. D
165C-2	1/8	5/16-24	.82	.61	.094
165C-3	3/16	3/8-24	.87	.61	.125
165C-4	1/4	7/16-24	.88	.61	.188
265C-4	1/4	7/16-24	.84	.60	.188
165C-5	5/16	1/2-24	.95	.71	.250
165C-6	3/8	9/16-24	1.03	.74	.312
165C-7	7/16	5/3-24	1.16	.82	.312
165C-8	1/2	11/16-20	1.34	.93	.406
165C-10	5/8	13/16-18	1.48	1.05	.500
165C-12	3/4	1-18	1.65	1.17	.560

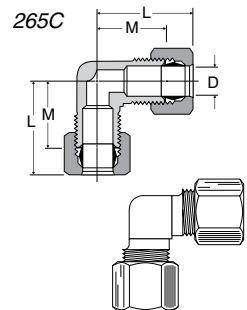
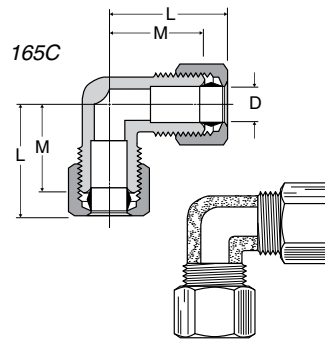

**Compression Gage Tee 168C**

PART NO.	TUBE SIZE	PIPE THREAD	STRAIGHT THREAD	L	M	N	N1	FLOW DIA. D
168C-4-2	1/4	1/8	7/16-24	.96	.72	1.41	.56	.188

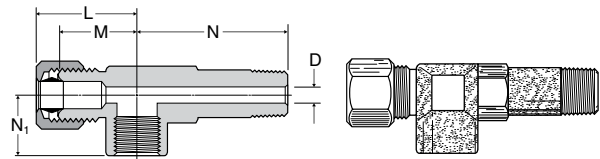

**A**

**Male Elbow 169C-269C**

Ref. SAE 060202 BA

PART NO.	TUBE SIZE	PIPE THREAD	STRAIGHT THREAD	L	M	N	FLOW DIA. D
169C-2-1	1/8	1/16	5/16-24	.81	.60	.67	.095
269C-2-2	1/8	1/8	5/16-24	.80	.60	.67	.094
169C-3-1	3/16	1/16	3/8-24	.85	.61	.67	.126
169C-3-2	3/16	1/8	3/8-24	.84	.61	.69	.125
269C-3-2	3/16	1/8	3/8-24	.84	.60	.67	.125
169C-3-4	3/16	1/4	3/8-24	.86	.64	.93	.125
169C-4-2	1/4	1/8	7/16-24	.86	.61	.74	.188
269C-4-2	1/4	1/8	7/16-24	.84	.60	.73	.188
169C-4-4	1/4	1/4	7/16-24	.86	.62	.94	.188
269C-4-4	1/4	1/4	7/16-24	.84	.60	.79	.188
169C-4-6	1/4	3/8	7/16-24	.93	.68	1.00	.188
169C-5-2	5/16	1/8	1/2-24	.88	.61	.74	.234
269C-5-2	5/16	1/8	1/2-24	.86	.60	.73	.250
169C-5-4	5/16	1/4	1/2-24	.95	.71	.93	.250
269C-5-4	5/16	1/4	1/2-24	.93	.67	.82	.250
169C-5-6	5/16	3/8	1/2-24	1.01	.75	1.00	.250
169C-6-2	3/8	1/8	9/16-24	1.03	.74	.74	.234
269C-6-2	3/8	1/8	9/16-24	.97	.69	.75	.220
169C-6-4	3/8	1/4	9/16-24	1.03	.74	.93	.312
269C-6-4	3/8	1/4	9/16-24	1.01	.73	.92	.312
169C-6-6	3/8	3/8	9/16-24	1.03	.75	1.00	.312
269C-6-6	3/8	3/8	9/16-24	1.12	.84	.97	.312
169C-6-8	3/8	1/2	9/16-24	1.22	.94	1.27	.312
269C-7-6	7/16	3/8	5/8-24	1.16	.82	.98	.312
169C-8-4	1/2	1/4	11/16-20	1.34	.94	1.00	.312
169C-8-6	1/2	3/8	11/16-20	1.34	.93	1.11	.406
169C-8-8	1/2	1/2	11/16-20	1.48	1.00	1.37	.406
169C-10-8	5/8	1/2	13/16-18	1.48	1.06	1.31	.500
169C-12-8	3/4	1/2	1-18	1.64	1.18	1.49	.562
169C-12-12	3/4	3/4	1-18	1.70	1.27	1.58	.562

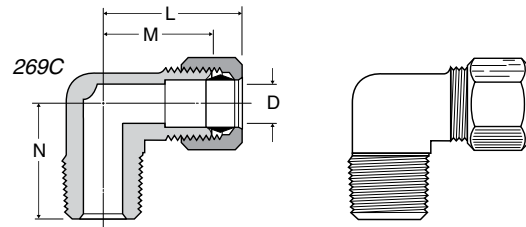
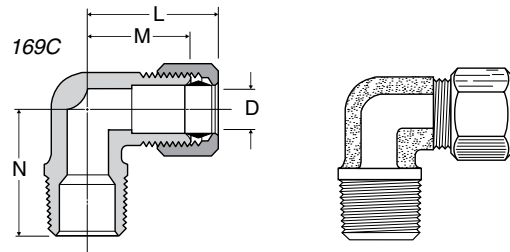

**Female Elbow 170C-270C**

Ref. SAE 060203 BA

PART NO.	TUBE SIZE	PIPE THREAD	STRAIGHT THREAD	L	M	N	FLOW DIA. D
170C-2-2	1/8	1/8	5/16-24	.89	.69	.56	.094
170C-3-2	3/16	1/8	3/8-24	.98	.73	.56	.125
170C-4-2	1/4	1/8	7/16-24	.93	.69	.56	.188
270C-4-2	1/4	1/8	7/16-24	.91	.67	.54	.188
170C-4-4	1/4	1/4	7/16-24	1.02	.78	.70	.188
170C-6-4	3/8	1/4	9/16-24	1.06	.79	.73	.312
170C-6-6	3/8	3/8	9/16-24	1.22	.94	.69	.312
170C-7-4	7/16	1/4	5/8-24	1.27	.93	.73	.312
170C-8-6	1/2	3/8	11/16-20	1.34	1.00	.69	.406
170C-8-8	1/2	1/2	11/16-20	1.56	1.15	.97	.408
170C-12-12	3/4	3/4	1-18	2.06	1.58	1.58	.560

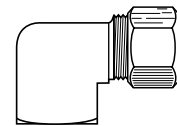
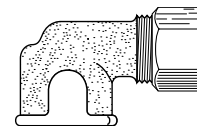
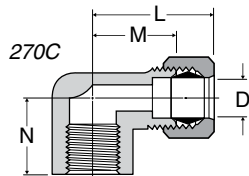
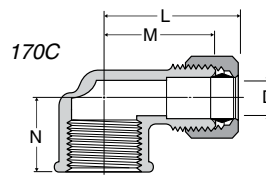

**Male Run Tee 171C**

Ref. SAE 060424 BA

PART NO.	TUBE SIZE	PIPE THREAD	STRAIGHT THREAD	L	M	N	FLOW DIA. D
171C-2-2	1/8	1/8	5/16-24	.82	.61	.71	.094
171C-3-2	3/16	1/8	3/8-24	.86	.61	.71	.125
171C-4-2	1/4	1/8	7/16-24	.90	.64	.75	.188
171C-4-4	1/4	1/4	7/16-24	.93	.69	.92	.188
171C-6-4	3/8	1/4	9/16-24	1.09	.81	1.03	.312

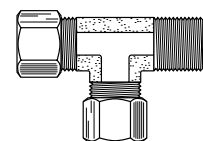
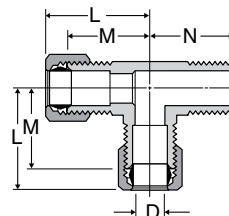



**Male Branch Tee 172C**

Ref. SAE 060425 BA

PART NO.	TUBE SIZE	PIPE THREAD	STRAIGHT THREAD	L	M	N	FLOW DIA. D
172C-2-2	1/8	1/8	5/16-24	.82	.61	.71	.094
172C-3-2	3/16	1/8	3/8-24	.86	.61	.71	.125
172C-4-2	1/4	1/8	7/16-24	.86	.61	.74	.188
172C-4-4	1/4	1/4	7/16-24	.93	.69	.92	.188
172C-6-2	3/8	1/8	9/16-24	1.03	.75	.75	.234
172C-6-4	3/8	1/4	9/16-24	1.09	.77	1.03	.312
172C-6-6	3/8	3/8	9/16-24	1.09	.81	1.00	.312
172C-8-6	1/2	3/8	11/16-20	1.34	.93	1.10	.406

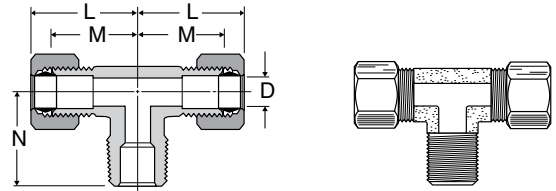

**Adapter Tee 176C**

PART NO.	TUBE SIZE	PIPE THREAD	STRAIGHT THREAD	L	M	N	N1	FLOW DIA. D
176C-4-2	1/4	1/8	7/16-24	.93	.69	.75	.66	.188

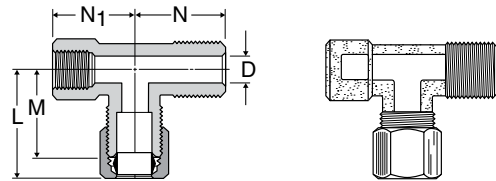

**Female Branch Tee 177C**

PART NO.	TUBE SIZE	PIPE THREAD	STRAIGHT THREAD	L	M	N	FLOW DIA. D
177C-4-2	1/4	1/8	7/16-24	.86	.63	.53	.188

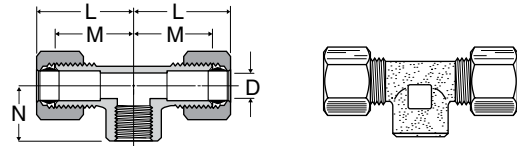

**45° Elbow 179C**

Compression to male pipe

PART NO.	TUBE SIZE	PIPE THREAD	STRAIGHT THREAD	L	M	N	FLOW DIA. D
179C-4-2	1/4	1/8	7/16-24	.90	.66	.56	.188
179C-4-4	1/4	1/4	7/16-24	.80	.56	.84	.188
179C-6-2	3/8	1/8	9/16-24	.90	.63	.65	.234
179C-6-4	3/8	1/4	9/16-24	.90	.63	.84	.312
179C-6-6	3/8	3/8	9/16-24	.97	.75	.95	.312
179C-8-6	1/2	3/8	11/16-24	1.15	.81	.95	.406

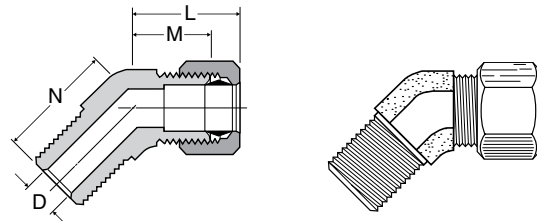

**A**

**Seal Plug 639C**

PART NO.	TUBE SIZE	STRAIGHT THREAD	C HEX	L	M
639C-4	1/4	7/16-24	7/16	.74	.50

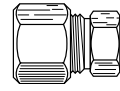
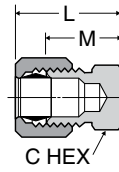

**Straight Through Tank Fitting 682C**

PART NO.	TUBE SIZE	PIPE THREAD	STRAIGHT THREAD	C HEX	L	M	FLOW DIA. D
682C-3-2	3/16	1/8	3/8-24	7/16	1.06	0.84	.195
682C-6-6	3/8	3/8	9/16-24	11/16	1.44	1.16	.387
682C-8-8	1/2	1/2	11/16-20	7/8	1.90	1.31	.516

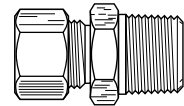
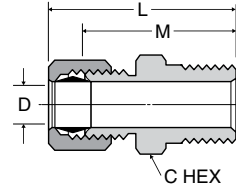

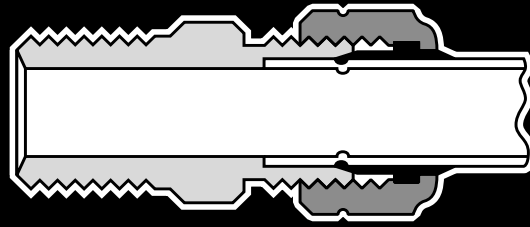

## Compress-Align® Fittings

### Advantages

No flaring, soldering or other preparation of tubing is necessary. Pre-assembled fitting, with captive sleeve. Sleeve is always oriented for correct installation, visible for inspection before and after installation. Heavy-duty fitting aligns to seal even out-of-round tubing. More quickly assembled than either flare or standard tapered sleeve compression fittings. Compress-Align bodies are interchangeable with standard compression fitting bodies. This economical fitting is available in straights, tees and elbows 1/8 in. O.D. through 1 in. O.D. tube size. Manufactured from CA 360, CA 345 or CA 377 brass.

### Specifications

Listed with Underwriter's Laboratories for flammable liquids. Consult list of UL listed fittings on page M10 for specific configurations.

### Applications

Use with annealed copper, brass, aluminum and thermoplastic tubing. Manufactured for low and medium pressure tubing connections.

PSI	Tube O.D. (in.)	Tube Wall (in.)
2800	1/8	.030
1900	3/16	.030
1400	1/4	.030
1200	5/16	.032
1000	3/8	.032
750	1/2	.032
650	5/8	.035
550	3/4	.035
450	7/8	.035
350	1	.035

### Temperature Ranges

From -65° to +250°F.

### Vibration

Fair resistance to minimal vibration or tube movement.

### Assembly Instructions

With nut finger tight on fitting body, insert tubing until it bottoms in the fitting. Complete the seal with one wrench turn on all sizes.

### Order

By part number and name.

### Nomenclature

Part numbers are constructed from symbols that identify the style and size of the fitting. The first series of numbers and letters identifies the style and type fitting. The second series of numbers describes the size.

#### Example:

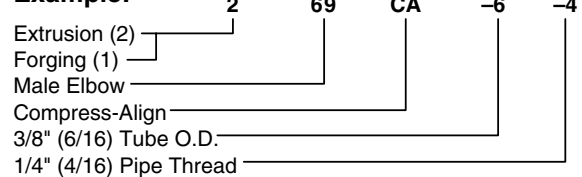

### Sizes

Tube sizes are determined by the number of sixteenths of an inch O.D.

### Special Fittings

Fitting configurations and/or sizes other than those shown in the catalog can be furnished. It is suggested that a print or sketch be submitted with the inquiry.

### Pricing

Only items priced in current supplementary price list PL3501 are carried in stock. Price and delivery for non-stock items furnished on request for specified quantity.

### Remake Instructions

Tighten to original make-up position plus 1/16 turn to reseal sleeve. Approximately 8 remakes are possible using this reassembly method.

**A**

**Plug 59CA**

PART NO.	TUBE SIZE	STRAIGHT THREAD	C HEX	L
59CA-4	1/4	7/16-24	1/2	.40
59CA-6	3/8	9/16-24	5/8	.45
59CA-8	1/2	11/16-20	13/16	.50

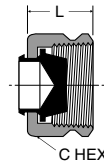

**Nut and Sleeve Assembly 61CA**

PART NO.	TUBE SIZE	STRAIGHT THREAD	C HEX	D	L
61CA-2	1/8	5/16-24	3/8	.130	.36
61CA-3	3/16	3/8-24	7/16	.194	.38
61CA-4	1/4	7/16-24	1/2	.255	.40
61CA-5	5/16	1/2-24	9/16	.318	.42
61CA-6	3/8	9/16-24	5/8	.382	.45
61CA-8	1/2	11/16-20	13/16	.507	.50
61CA-10	5/8	13/16-18	15/16	.632	.53
61CA-12	3/4	1-18	1-3/16	.760	.56
61CA-14	7/8	1-1/8-18	1-3/8	.885	.68
61CA-16	1	1-1/4-18	1-1/2	1.012	.63

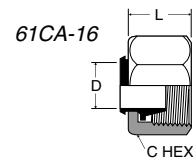
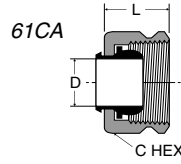

**Union 62CA**

PART NO.	TUBE SIZE	STRAIGHT THREAD	C HEX	L	M	FLOW DIA. D
62CA-2	1/8	5/16-24	5/16	1.12	.64	.094
62CA-3	3/16	3/8-24	3/8	1.19	.72	.125
62CA-4	1/4	7/16-24	7/16	1.26	.79	.188
62CA-5	5/16	1/2-24	1/2	1.32	.85	.250
62CA-6	3/8	9/16-24	9/16	1.42	.97	.312
62CA-8	1/2	11/16-20	11/16	1.53	1.08	.406
62CA-10	5/8	13/16-18	13/16	1.71	1.23	.500
62CA-12	3/4	1-18	1	2.20	1.41	.562
62CA-14	7/8	1-1/8-18	1-1/8	2.08	1.19	.766

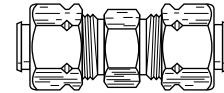
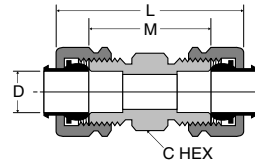

**Union Reducers 62CA**

PART NO.	1 TUBE SIZE	2 TUBE SIZE	1 STRAIGHT THREAD	2 STRAIGHT THREAD	C HEX	L	M	FLOW DIA. D
62CA-4-3	3/16	1/4	3/8-24	7/16-24	7/16	1.25	.78	.125
62CA-6-4	1/4	3/8	7/16-24	9/16-24	9/16	1.37	.91	.188
62CA-8-6	3/8	1/2	9/16-24	11/16-20	11/16	1.48	1.03	.312
62CA-10-6	3/8	5/8	9/16-24	13/16-18	13/16	1.59	1.13	.312

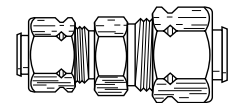
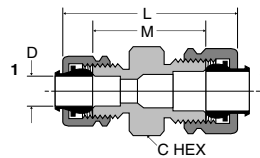

**Bulkhead Union 62CABH**

PART NO.	TUBE SIZE	STRAIGHT THREAD	C HEX	L	M	BULKHEAD HOLE DIA.	FLOW DIA. D
62CABH-4	1/4	7/16-24	9/16	2.22	1.75	7/16	.188
62CABH-6	3/8	9/16-24	11/16	2.32	1.88	9/16	.312

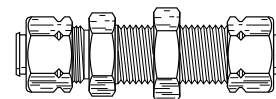
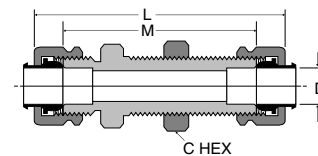



**Union 62PCA**

(Poly-Tite to Compress-Align)

PART NO.	TUBE SIZE	1 STRAIGHT THREAD	2 STRAIGHT THREAD	C HEX	L	M	FLOW DIA. D
62PCA-4	1/4	3/8-24	7/16-24	7/16	1.24	.89	.125
62PCA-5	5/16	7/16-24	1/2-24	1/2	1.26	.92	.144
62PCA-6	3/8	1/2-24	9/16-24	9/16	1.32	.98	.204

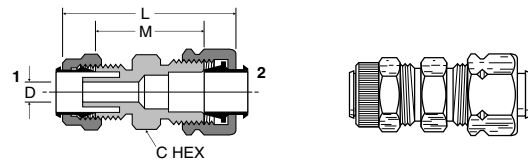

**Bulkhead Union 62PCABH**

(Poly-Tite to Compress-Align)

PART NO.	TUBE SIZE	1 STRAIGHT THREAD	2 STRAIGHT THREAD	C HEX	P MAX	L	M	BULKHEAD HOLE DIA.	FLOW DIA. D
62PCABH-4	1/4	3/8-24	7/16-24	9/16	.38	1.80	1.45	3/8	.125
62PCABH-6	3/8	1/2-24	9/16-24	11/16	.47	1.98	1.64	1/2	.204

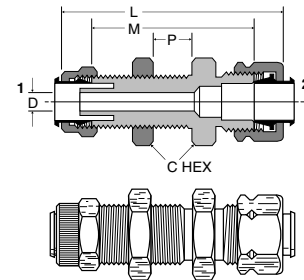

**Brass Insert 63PT**

(For industrial grade plastic tubing)

PART NO.	TUBE SIZE	TUBE WALL	L	O.D.
63PT-2-16	1/8	.016	.46	.080
63PT-2-23	1/8	.023	.45	.073
63PT-2-32	1/8	.032	.31	.061
63PT-3-25	3/16	.025	.45	.135
63PT-3-40	3/16	.040	.52	.095
63PT-4-40	1/4	.040	.50	.163
63PT-4-62	1/4	.062	.33	.110
63PT-5-40	5/16	.040	.50	.232
63PT-5-62	5/16	.062	.53	.187
63PT-6-62	3/8	.062	.56	.250
63PT-8-62	1/2	.062	.72	.370
63PT-10-62	5/8	.062	.72	.483

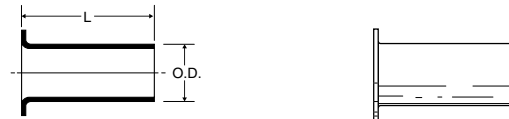

**Female Connector 66CA**

PART NO.	TUBE SIZE	PIPE THREAD	STRAIGHT THREAD	C HEX	L	M	FLOW DIA. D
66CA-2-2	1/8	1/8	5/16-24	9/16	.99	.75	.094
66CA-3-2	3/16	1/8	3/8-24	9/16	1.01	.78	.125
66CA-3-4	3/16	1/4	3/8-24	11/16	1.19	.96	.125
66CA-4-2	1/4	1/8	7/16-24	9/16	1.02	.78	.188
66CA-4-4	1/4	1/4	7/16-24	11/16	1.24	1.00	.188
66CA-5-2	5/16	1/8	1/2-24	9/16	1.05	.81	.250
66CA-5-4	5/16	1/4	1/2-24	11/16	1.27	1.03	.250
66CA-6-2	3/8	1/8	9/16-24	9/16	1.00	.78	.312
66CA-6-4	3/8	1/4	9/16-24	11/16	1.28	1.06	.312
66CA-6-6	3/8	3/8	9/16-24	13/16	1.29	1.06	.312
66CA-6-8	3/8	1/2	9/16-24	1	1.49	1.27	.312
66CA-8-4	1/2	1/4	11/16-20	11/16	1.32	1.09	.406
66CA-8-6	1/2	3/8	11/16-20	13/16	1.35	1.12	.406
66CA-8-8	1/2	1/2	11/16-20	1	1.54	1.31	.406
66CA-10-8	5/8	1/2	13/16-18	1	1.62	1.38	.500

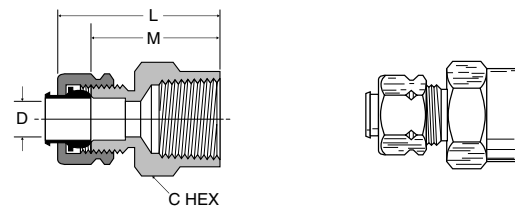

**A**

**Male Connector 68CA**

PART NO.	TUBE SIZE	PIPE THREAD	STRAIGHT THREAD	C HEX	L	M	FLOW DIA. D
68CA-2-1	1/8	1/16	5/16-24	11/32	1.02	.78	.095
68CA-2-2	1/8	1/8	5/16-24	7/16	1.01	.77	.094
68CA-3-1	3/16	1/16	3/8-24	3/8	1.07	.84	.125
68CA-3-2	3/16	1/8	3/8-24	7/16	1.07	.84	.125
68CA-3-4	3/16	1/4	3/8-24	9/16	1.26	1.03	.125
68CA-4-2	1/4	1/8	7/16-24	7/16	1.10	.86	.188
68CA-4-4	1/4	1/4	7/16-24	9/16	1.31	1.06	.188
68CA-4-6	1/4	3/8	7/16-24	11/16	1.28	1.03	.188
68CA-4-8	1/4	1/2	7/16-24	7/8	1.56	1.31	.188
68CA-5-2	5/16	1/8	1/2-24	1/2	1.13	.89	.234
68CA-5-4	5/16	1/4	1/2-24	9/16	1.35	1.07	.250
68CA-6-2	3/8	1/8	9/16-24	9/16	1.19	.97	.250
68CA-6-4	3/8	1/4	9/16-24	9/16	1.36	1.14	.312
68CA-6-6	3/8	3/8	9/16-24	11/16	1.43	1.16	.312
68CA-6-8	3/8	1/2	9/16-24	7/8	1.52	1.25	.312
68CA-8-4	1/2	1/4	11/16-20	11/16	1.45	1.22	.312
68CA-8-6	1/2	3/8	11/16-20	11/16	1.43	1.20	.406
68CA-8-8	1/2	1/2	11/16-20	7/8	1.54	1.31	.406
68CA-10-6	5/8	3/8	13/16-18	13/16	1.55	1.31	.406
68CA-10-8	5/8	1/2	13/16-18	7/8	1.72	1.48	.500
68CA-10-12	5/8	3/4	13/16-18	1-1/16	1.80	1.56	.500
68CA-12-8	3/4	1/2	1-18	1	1.99	1.60	.562
68CA-12-12	3/4	3/4	1-18	1-1/16	2.02	1.63	.656
68CA-14-12	7/8	3/4	1-1/8-18	1-1/8	1.85	1.41	.750
68CA-16-12	1	3/4	1-1/4-18	1-1/4	1.83	1.39	.750
68CA-16-16	1	1	1-1/4-18	1-3/8	2.02	1.58	.875

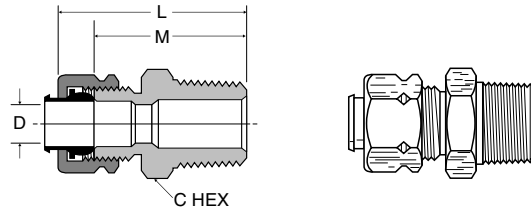

**Union Tee 164CA-264CA**

PART NO.	TUBE SIZE	STRAIGHT THREAD	L	M	FLOW DIA. D
164CA-2	1/8	5/16-24	.84	.61	.093
264CA-3	3/16	3/8-24	.83	.60	.125
164CA-4	1/4	7/16-24	.84	.61	.188
264CA-4	1/4	7/16-24	.84	.60	.188
164CA-5	5/16	1/2-24	.95	.71	.250
164CA-6	3/8	9/16-24	.96	.74	.312
164CA-8	1/2	11/16-20	1.15	.93	.406
164CA-10	5/8	13/16-18	1.32	1.08	.500
164CA-12	3/4	1.00-18	1.56	1.17	.560

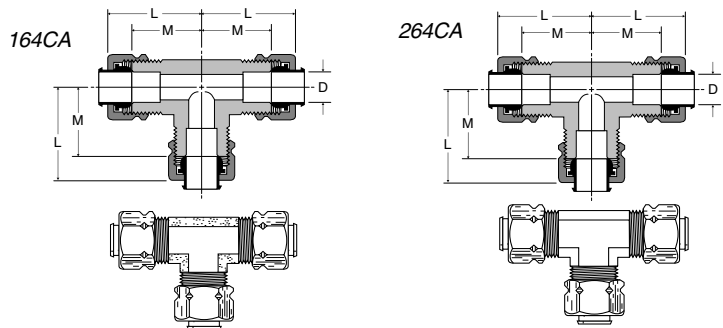

**Union Tee 164CA combination sizes**

PART NO.	1 TUBE SIZE	2 TUBE SIZE	3 TUBE SIZE	L1	L2	L3	M1	M2	M3	FLOW DIA. D
164CA-6-4-4	3/8	1/4	1/4	.97	.96	.96	.75	.72	.72	.188
164CA-6-6-4	3/8	3/8	1/4	.97	.97	.96	.75	.75	.72	.188
164CA-8-8-6	1/2	1/2	3/8	1.17	1.17	1.10	.94	.94	.88	.312

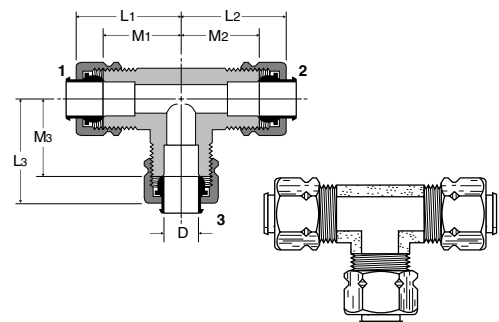





**Union Elbow 165CA-265CA**

PART NO.	TUBE SIZE	STRAIGHT THREAD	L	M	FLOW DIA. D
165CA-2	1/8	5/16-24	.84	.61	.094
165CA-3	3/16	3/8-24	.84	.61	.125
165CA-4	1/4	7/16-24	.84	.61	.188
265CA-4	1/4	7/16-24	.84	.60	.188
165CA-5	5/16	1/2-24	.94	.71	.250
165CA-6	3/8	9/16-24	.96	.74	.312
165CA-8	1/2	1 1/16-20	1.15	.93	.406
165CA-10	5/8	1 3/16-18	1.29	1.05	.500
165CA-12	3/4	1-18	1.56	1.17	.560
165CA-16	1	1-1/4-18	1.63	1.19	.877

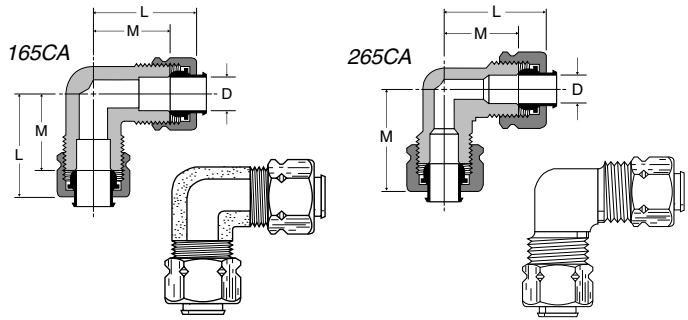

**Gage Tee 168CA**

PART NO.	TUBE SIZE	PIPE THREAD	STRAIGHT THREAD	L	M	N	N1	FLOW DIA. D
168CA-4-2	1/4	1/8	7/16-24	.96	.72	1.41	.56	.188

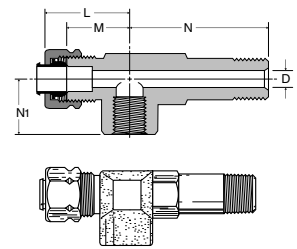

**Male Elbow 169CA-269CA**

PART NO.	TUBE SIZE	PIPE THREAD	STRAIGHT THREAD	L	M	N	FLOW DIA. D
169CA-2-1	1/8	1/16	5/16-24	.84	.60	.67	.095
269CA-2-2	1/8	1/8	5/16-24	.84	.60	.67	.094
169CA-3-1	3/16	1/16	3/8-24	.84	.61	.67	.126
169CA-3-2	3/16	1/8	3/8-24	.84	.61	.69	.125
269CA-3-2	3/16	1/8	3/8-24	.83	.60	.67	.125
169CA-3-4	3/16	1/4	3/8-24	.87	.64	.93	.125
169CA-4-2	1/4	1/8	7/16-24	.84	.61	.74	.188
269CA-4-2	1/4	1/8	7/16-24	.84	.60	.73	.188
169CA-4-4	1/4	1/4	7/16-24	.86	.62	.94	.188
269CA-4-4	1/4	1/4	7/16-24	.84	.60	.79	.188
169CA-4-6	1/4	3/8	7/16-24	.92	.68	1.00	.188
169CA-5-2	5/16	1/8	1/2-24	.84	.61	.74	.234
269CA-5-2	5/16	1/8	1/2-24	.84	.60	.73	.250
169CA-5-4	5/16	1/4	1/2-24	.94	.71	.93	.250
269CA-5-4	5/16	1/4	1/2-24	.91	.67	.82	.250
169CA-5-6	5/16	3/8	1/2-24	.99	.75	1.00	.250
169CA-6-2	3/8	1/8	9/16-24	.96	.74	.74	.234
269CA-6-2	3/8	1/8	9/16-24	.96	.69	.75	.220
169CA-6-4	3/8	1/4	9/16-24	.96	.74	.93	.312
269CA-6-4	3/8	1/4	9/16-24	.95	.73	.92	.312
169CA-6-6	3/8	3/8	9/16-24	.97	.75	1.00	.312
269CA-6-6	3/8	3/8	9/16-24	1.06	.84	.97	.312
169CA-6-8	3/8	1/2	9/16-24	1.16	.94	1.27	.312
169CA-8-4	1/2	1/4	1 1/16-20	1.17	.94	1.00	.312
169CA-8-6	1/2	3/8	1 1/16-20	1.15	.93	1.11	.406
169CA-8-8	1/2	1/2	1 1/16-20	1.23	1.00	1.37	.406
169CA-10-6	5/8	3/8	1 3/16-18	1.30	1.06	1.15	.406
169CA-10-8	5/8	1/2	1 3/16-18	1.30	1.06	1.31	.500
169CA-12-8	3/4	1/2	1-18	1.57	1.18	1.49	.562
169CA-12-12	3/4	3/4	1-18	1.66	1.27	1.58	.562
169CA-16-12	1	3/4	1-1/4-18	1.63	1.19	1.60	.875

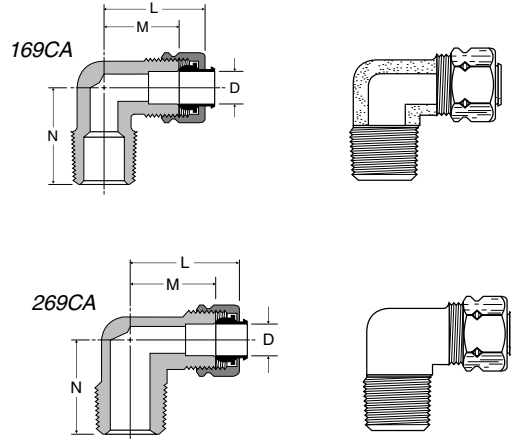

**A**

**Female Elbow 170CA-270CA**

PART NO.	TUBE SIZE	PIPE THREAD	STRAIGHT THREAD	L	M	N	FLOW DIA. D
170CA-2-2	1/8	1/8	5/16-24	.93	.69	.56	.094
170CA-3-2	3/16	1/8	3/8-24	.98	.69	.56	.125
170CA-4-2	1/4	1/8	7/16-24	.98	.69	.56	.188
270CA-4-2	1/4	1/8	7/16-24	.91	.67	.54	.188
170CA-4-4	1/4	1/4	7/16-24	1.02	.78	.70	.188
170CA-6-4	3/8	1/4	9/16-24	1.09	.79	.73	.312
170CA-6-6	3/8	3/8	9/16-24	1.16	.94	.69	.312
170CA-8-6	1/2	3/8	11/16-20	1.23	1.00	.69	.406
170CA-8-8	1/2	1/2	11/16-20	1.38	1.15	.97	.408
170CA-12-12	3/4	3/4	1-18	1.97	1.58	1.58	.560

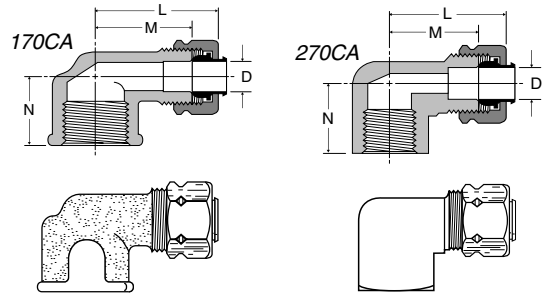

**Male Run Tee 171CA**

PART NO.	TUBE SIZE	PIPE THREAD	STRAIGHT THREAD	L	M	N	FLOW DIA. D
171CA-2-2	1/8	1/8	5/16-24	.84	.61	.71	.094
171CA-3-2	3/16	1/8	3/8-24	.83	.61	.71	.125
171CA-4-2	1/4	1/8	7/16-24	.88	.64	.75	.188
171CA-4-4	1/4	1/4	7/16-24	.93	.69	.92	.188
171CA-6-4	3/8	1/4	9/16-24	1.03	.81	1.03	.312

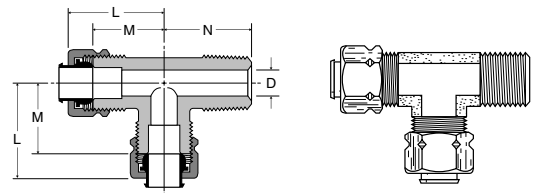

**Male Branch Tee 172CA**

PART NO.	TUBE SIZE	PIPE THREAD	STRAIGHT THREAD	L	M	N	FLOW DIA. D
172CA-2-2	1/8	1/8	5/16-24	.84	.61	.71	.093
172CA-3-2	3/16	1/8	3/8-24	.83	.61	.71	.125
172CA-4-2	1/4	1/8	7/16-24	.84	.61	.74	.188
172CA-4-4	1/4	1/4	7/16-24	.93	.69	.92	.188
172CA-6-2	3/8	1/8	9/16-24	.97	.75	.75	.234
172CA-6-4	3/8	1/4	9/16-24	.99	.77	1.03	.312
172CA-6-6	3/8	3/8	9/16-24	1.03	.81	1.00	.312
172CA-8-6	1/2	3/8	11/16-20	1.15	.93	1.10	.406
172CA-12-12	3/4	3/4	1-18	1.67	1.27	1.50	.562

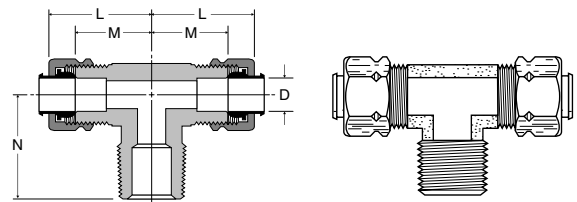

**Adapter Tee 176CA**

PART NO.	TUBE SIZE	PIPE THREAD	STRAIGHT THREAD	L	M	N	N1	FLOW DIA. D
176CA-4-2	1/4	1/8	7/16-24	.92	.69	.75	.66	.188

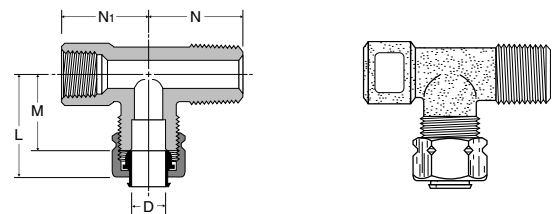

**Female Branch Tee 177CA**

PART NO.	TUBE SIZE	PIPE THREAD	STRAIGHT THREAD	L	M	N	FLOW DIA. D
177CA-4-2	1/4	1/8	7/16-24	.86	.63	.53	.188

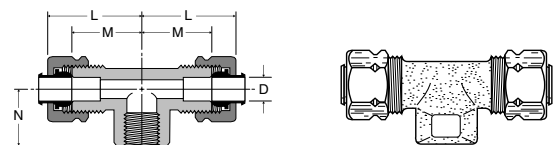



**45° Elbow 179CA**

PART NO.	TUBE SIZE	PIPE THREAD	STRAIGHT THREAD	L	M	N	FLOW DIA. D
179CA-4-2	1/4	1/8	7/16-24	.89	.66	.56	.188
179CA-4-4	1/4	1/4	7/16-24	.80	.56	.84	.188
179CA-6-2	3/8	1/8	9/16-24	.85	.63	.65	.234
179CA-6-4	3/8	1/4	9/16-24	.85	.63	.84	.281
179CA-6-6	3/8	3/8	9/16-24	.97	.75	.95	.312
179CA-8-6	1/2	3/8	11/16-20	1.03	.81	.95	.406

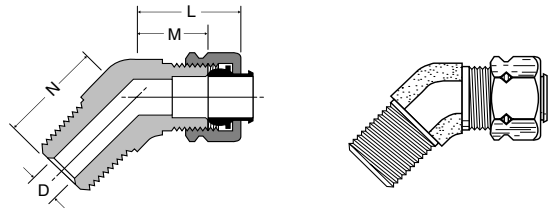

**Seal Plug 639CA**

PART NO.	TUBE SIZE	STRAIGHT THREAD	C HEX	L	M
639CA-4	1/4	7/16-24	7/16	.74	.50

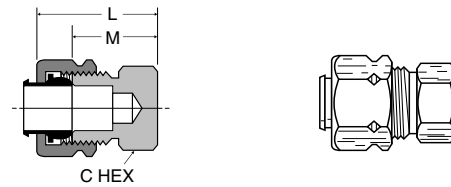

**Straight Through Tank Fitting 682CA**

PART NO.	TUBE SIZE	PIPE THREAD	STRAIGHT THREAD	C HEX	L	M	FLOW DIA. D
682CA-3-2	3/16	1/8	3/8-24	7/16	1.07	.84	.194

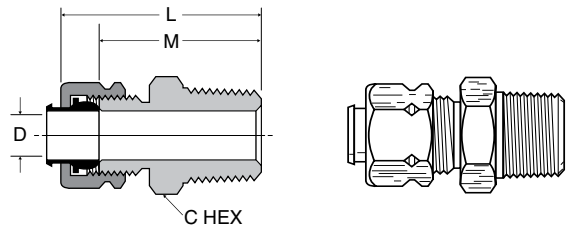

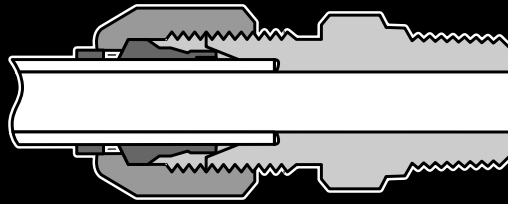

# Parker Metru-Lok™ Fittings

## Advantages

Metru-Lok™ is a one-piece, ready-to-use, bite-type fitting for use with either copper or plastic tubing. The ferrule is held captive in the nut. The fitting is designed to permit tube entry and fitting makeup without removal of the nut and ferrule, avoiding the assembly of the fitting components prior to use.

## Fitting ready to use

- Compact fully assembled fitting, timesaving at makeup.
- Captive snap in ferrule.
- Simplified handling and stock-keeping.
- No presetting of the ferrule necessary.

## Positive sealing and bite

- The wedging action of the nut when tightened causes the ferrule to bite into the outside diameter of the tube wall for a leakproof connection.
- With flexible tubing (polyurethane, PEBA or polyethylene), it is recommended to use a tube insert for a positive holding of the tube.

## Safety

- Visible ferrule (extending to rear of nut) allows quality control checks for correct assembly.

## Excellent vibration resistance

- Vibration is contained by the rear compression of the ferrule extending outside the nut.
- The tube is held at the bottom of the fitting.
- The tube is thus held between the above two points so that vibration running along the tube does not affect the sealing and bite area.

## How to Use: Assembly

- Cut the tube square.
- De-burr (copper tube).
- Insert the tube through the nut and ferrule until it bottoms.
- Finger tighten the nut.
- Wrench tighten the nut one turn, or one and one half turns, according to size.

## Disassembly - remake

- The Metru-Lok™ fitting can be assembled and disassembled at least 15 times. At each remake, hand tighten the nut, then wrench tighten 1/16 of a turn.

## Technical Features

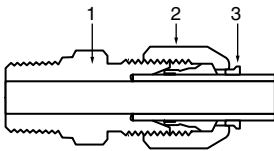

MATERIAL			WORKING TEMP.	WORKING PRESSURE* DEPENDING ON TUBE O.D.							
1	2	3		TUBE O.D. MM	4	6	8	10	12	14	16 to 20
BODY BRASS	NUT BRASS	FERRULE BRASS	FROM -65° TO +250° F	PSI	2600	2600	1800	1500	1300	1000	800

## Fitting Dimensions

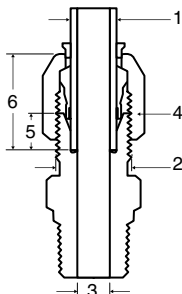

1 TUBE O.D. MM	2 METRIC STRAIGHT THREAD	3 INSIDE DIAMETER MM	4 HEX OF NUT MM	5 TUBE ENTRY BODY MM	6 TUBE ENTRY COMPL. FITTING MM	WRENCH TIGHTENING IN TURNS
4	M8x1	2	10	4	12	1 1/2
6	M10x1	4	12	5	13	1 1/2
8	M12x1	6	14	6	14	1 1/2
10	M14x1	8	17	6	14	1 1/2
12	M16x1	10	19	7	15	1 1/2
14	M18x1	12	22	8	16	1 1/2
16	M22x1.50	14	27	8	16	1
18	M24x1.50	16	30	9	21	1
20	M26x1.50	18	32	9	21	1
22	M28x1.50	20	36	10	22	1



**FBMB Male Connector NPT**

PART NO.	TUBE SIZE	NPT THREAD	C HEX	C1	L
FBMB4-1/16	4	1/16	8	10	26
FBMB4-1/8	4	1/8	11	10	27
FBMB6-1/8	6	1/8	11	12	28
FBMB6-1/4	6	1/4	14	12	32
FBMB8-1/8	8	1/8	12	14	29
FBMB8-1/4	8	1/4	14	14	33
FBMB10-1/4	10	1/4	14	17	33
FBMB10-3/8	10	3/8	19	17	34
FBMB12-3/8	12	3/8	19	19	35
FBMB12-1/2	12	1/2	22	19	40
FBMB14-3/8	14	3/8	19	22	36
FBMB14-1/2	14	1/2	22	22	41
FBMB16-1/2	16	1/2	22	27	40
FBMB18-1/2	18	1/2	24	30	46
FBMB20-3/4	20	3/4	27	32	47
FBMB22-3/4	22	3/4	30	36	49

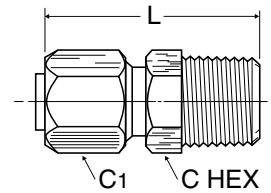

**F3BMB Male Connector BSPT**

PART NO.	TUBE SIZE	BSPT THREAD	C HEX	C1	L
F3BMB4-1/8	4	1/8	10	10	25
F3BMB6-1/8	6	1/8	11	12	27
F3BMB6-1/4	6	1/4	14	12	31
F3BMB8-1/8	8	1/8	12	14	29
F3BMB8-1/4	8	1/4	14	14	32
F3BMB8-3/8	8	3/8	17	17	34
F3BMB10-1/4	10	1/4	14	17	32
F3BMB10-3/8	10	3/8	17	17	33
F3BMB12-3/8	12	3/8	17	19	34
F3BMB12-1/2	12	1/2	22	19	39
F3BMB14-3/8	14	3/8	19	22	35
F3BMB14-1/2	14	1/2	22	22	40
F3BMB16-3/8	16	3/8	22	27	36
F3BMB16-1/2	16	1/2	22	27	39
F3BMB18-1/2	18	1/2	24	30	45
F3BMB20-3/4	20	3/4	27	32	46
F3BMB22-3/4	22	3/4	30	36	48

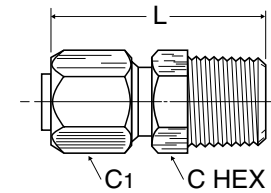

**F4BMB Male Connector BSPP**

PART NO.	TUBE SIZE	BSPP THREAD	C HEX	C1	L
F4BMB4-1/8	4	1/8	14	10	29
F4BMB6-1/8	6	1/8	14	12	30
F4BMB6-1/4	6	1/4	19	12	32
F4BMB8-1/4	8	1/4	19	14	33
F4BMB10-1/4	10	1/4	19	17	33

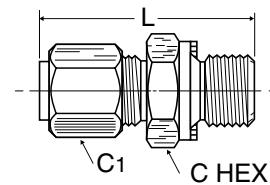

**F8BMB Male Connector Metric Straight Thread**

PART NO.	TUBE SIZE	MM THREAD	C HEX	C1	L
F8BMB4M5	4	M5x0.8	8	10	24
F8BMB12M16	12	M16x1.5	22	19	37
F8BMB12M22	12	M22x1.5	27	19	40
F8BMB14M16	14	M16x1.5	22	22	38
F8BMB14M22	14	M22x1.5	27	22	41
F8BMB16M16	16	M16x1.5	22	27	37
F8BMB16M22	16	M22x1.5	27	27	40

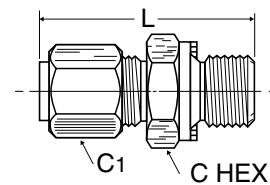

These parts are supplied with a copper seal.



**A**

**HBMB Equal Union**

PART NO.	TUBE SIZE	C HEX	C1	L
HBMB4	4	8	10	31
HBMB6	6	10	12	34
HBMB8	8	12	14	37
HBMB10	10	14	17	37
HBMB12	12	17	19	39
HBMB14	14	19	22	41
HBMB16	16	22	27	41
HBMB18	18	24	30	51
HBMB20	20	27	32	51
HBMB22	22	30	36	54

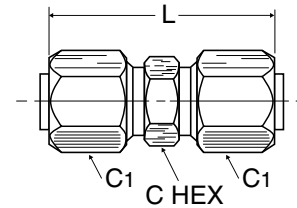

**GBMB Female Connector NPT**

PART NO.	TUBE SIZE	NPT THREAD	C HEX	C1	L
GBMB6-1/8	6	1/8	14	12	29
GBMB6-1/4	6	1/4	19	12	32
GBMB8-1/8	8	1/8	14	14	30
GBMB8-1/4	8	1/4	19	14	33
GBMB10-1/4	10	1/4	19	17	33
GBMB10-3/8	10	3/8	22	17	35
GBMB12-3/8	12	3/8	22	19	36
GBMB12-1/2	12	1/2	27	19	38
GBMB14-3/8	14	3/8	22	22	37
GBMB14-1/2	14	1/2	27	27	39
GBMB16-1/2	16	1/2	27	27	39

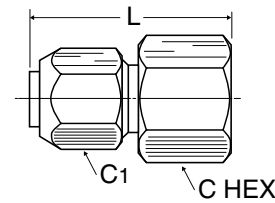

**G4BMB Female Connector BSPP**

PART NO.	TUBE SIZE	BSPP THREAD	C HEX	C1	L
G4BMB4-1/8	4	1/8	14	10	26
G4BMB6-1/8	6	1/8	14	12	27
G4BMB6-1/4	6	1/4	19	12	29
G4BMB8-1/8	8	1/8	14	14	28
G4BMB8-1/4	8	1/4	19	14	30
G4BMB10-1/4	10	1/4	19	17	30
G4BMB10-3/8	10	3/8	22	17	32
G4BMB12-3/8	12	3/8	22	19	33
G4BMB12-1/2	12	1/2	27	19	36
G4BMB14-3/8	14	3/8	22	22	34
G4BMB14-1/2	14	1/2	27	22	37
G4BMB16-1/2	14	1/2	27	27	37
G4BMB18-1/2	18	1/2	27	30	41

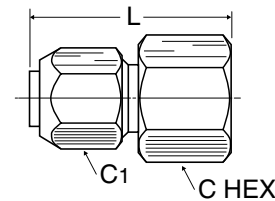

**WBMB Bulkhead Union**

PART NO.	TUBE SIZE	MM THREAD	C HEX	C1	L	L1	L2	BULKHEAD HOLE DIA.
WBMB4	4	M8x1	12	10	47	19	28	8mm
WBMB6	6	M10x1	14	12	49	20	29	10mm
WBMB8	8	M12x1	16	14	52	21	31	12mm
WBMB10	10	M14x1	19	17	53	22	31	14mm
WBMB12	12	M16x1	22	19	56	24	32	16mm
WBMB14	14	M18x1	24	22	60	26	34	18mm
WBMB16	16	M22x1.5	27	27	58	25	33	22mm
WBMB18	18	M24x1.5	30	30	70	31	39	24mm
WBMB20	20	M26x1.5	32	32	70	31	39	26mm
WBMB22	22	M28x1.5	36	36	74	33	41	28mm

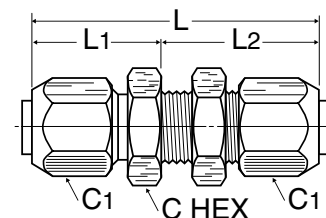



**WBMPB Mixed Bulkhead Union**

PART NO.	TUBE SIZE 1	TUBE SIZE 2	MM THREAD	C1	C HEX	L	W	BULKHEAD HOLE DIA.
WBMPB4	4	4	M8x1	10	12	34	5	8mm
WBMPB6	6	6	M10x1	12	12	37	5	10mm
WBMPB8	8	8	M12x1	14	16	39	5	12mm
WBMPB10	10	10	M14x1	17	19	45	5	14mm
WBMPB12	12	12	M16x1	19	22	49	5	16mm
WBMPB14	14	14	M18x1	22	22	52	7	18mm

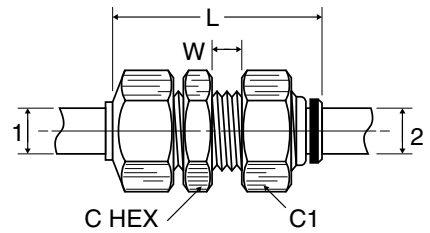

**CBMB 90° Male Elbow NPT**

PART NO.	TUBE SIZE	NPT THREAD	C1	M	N
CBMB4-1/8	4	1/8	10	22	17
CBMB6-1/8	6	1/8	12	24	18
CBMB6-1/4	6	1/4	12	24	22
CBMB8-1/8	8	1/8	14	26	19
CBMB8-1/4	8	1/4	14	26	23
CBMB10-1/4	10	1/4	17	27	24
CBMB10-3/8	10	3/8	17	28	25
CBMB12-3/8	12	3/8	19	32	27
CBMB12-1/2	12	1/2	19	32	31
CBMB14-3/8	14	3/8	22	32	26
CBMB14-1/2	14	1/2	22	33	31
CBMB16-1/2	16	1/2	27	35	34
CBMB18-1/2	18	1/2	30	41	35
CBMB20-3/4	20	3/4	32	45	40
CBMB22-3/4	22	3/4	36	46	40

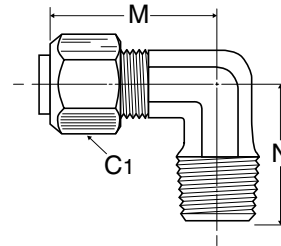

**C3BMB 90° Male Elbow BSPT**

PART NO.	TUBE SIZE	BSPT THREAD	C1	M	N
C3BMB4-1/8	4	1/8	10	22	17
C3BMB6-1/8	6	1/8	12	24	18
C3BMB6-1/4	6	1/4	12	24	22
C3BMB8-1/8	8	1/8	14	26	19
C3BMB8-1/4	8	1/4	14	26	23
C3BMB10-1/4	10	1/4	17	27	24
C3BMB10-3/8	10	3/8	17	28	25
C3BMB12-3/8	12	3/8	19	32	27
C3BMB12-1/2	12	1/2	19	32	31
C3BMB14-3/8	14	3/8	22	32	26
C3BMB14-1/2	14	1/2	22	32	31
C3BMB16-1/2	16	1/2	27	35	34
C3BMB18-1/2	18	1/2	30	41	35
C3BMB22-3/4	22	3/4	36	46	40

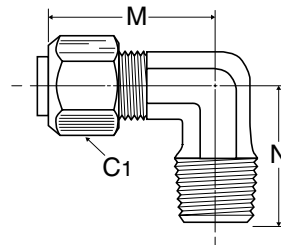

**C8BMB 90° Adjustable Male Elbow Metric Straight Thread**

PART NO.	TUBE SIZE	MM THREAD	C1	C4	M	N
C8BMB12M16	12	M16x1.5	19	22	32	35
C8BMB12M22	12	M22x1.5	19	30	35	39
C8BMB14M16	14	M16x1.5	22	22	32	33
C8BMB14M22	14	M22x1.5	22	30	35	39
C8BMB16M16	16	M16x1.5	24	22	35	36
C8BMB16M22	16	M22x1.5	27	30	36	39

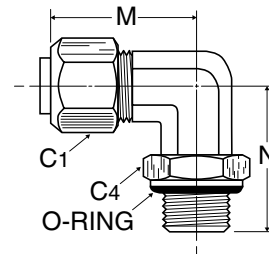

**A**

**EBMB 90° Union Elbow**

PART NO.	TUBE SIZE	C1	L	Y
EBMB4	4	10	22	7
EBMB6	6	12	24	8
EBMB8	8	14	26	10
EBMB10	10	17	27	12
EBMB12	12	19	32	14
EBMB14	14	22	32	16
EBMB16	16	27	35	18
EBMB18	18	30	41	20
EBMB20	20	32	45	24

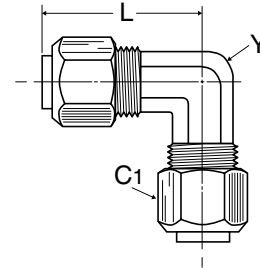

**JBMB Union Tee**

PART NO.	TUBE SIZE	C1	L	M
JBMB4	4	10	47	23.5
JBMB6	6	12	48	24.0
JBMB8	8	14	52	26.0
JBMB10	10	17	54	27.0
JBMB12	12	19	63	31.5
JBMB14	14	22	63	31.5
JBMB16	16	27	69	34.5
JBMB18	18	30	82	41.0
JBMB20	20	32	89	44.5
JBMB22	22	36	91	45.5

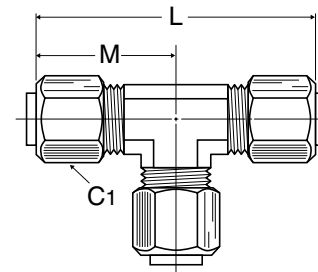

**RBMB Male Run Tee NPT**

PART NO.	TUBE SIZE	NPT THREAD	C1	L	M	N
RBMB6-1/4	6	1/4	12	48	25	23
RBMB8-1/8	8	1/8	14	45	26	19
RBMB8-1/4	8	1/4	14	49	26	23
RBMB10-1/4	10	1/4	17	51	27	24
RBMB10-3/8	10	3/8	17	52	28	24
RBMB12-3/8	12	3/8	19	59	32	27
RBMB12-1/2	12	1/2	19	63	32	31
RBMB14-3/8	14	3/8	22	60	33	28
RBMB14-1/2	14	1/2	22	64	33	31
RBMB16-1/2	16	1/2	22	69	35	34

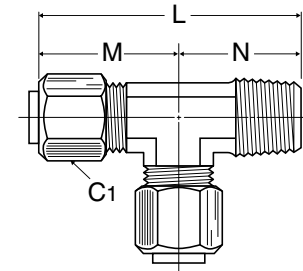

**R3BMB Male Run Tee BSPT**

PART NO.	TUBE SIZE	BSPT THREAD	C1	L	M	N
R3BMB6-1/8	6	1/8	12	42	24	18
R3BMB6-1/4	6	1/4	12	48	25	23
R3BMB8-1/8	8	1/8	14	45	26	19
R3BMB8-1/4	8	1/4	14	49	26	23
R3BMB10-1/4	10	1/4	17	51	27	24
R3BMB10-3/8	10	3/8	17	52	28	24
R3BMB12-3/8	12	3/8	19	59	32	27
R3BMB12-1/2	12	1/2	19	63	32	31
R3BMB14-3/8	14	3/8	22	59	32	28
R3BMB14-1/2	14	1/2	22	63	33	31
R3BMB16-1/2	16	1/2	27	69	35	34

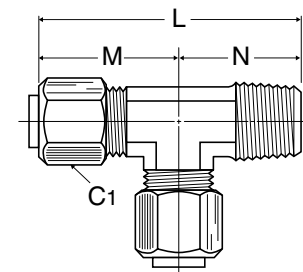



**A**

**SBMB Male Branch Tee NPT**

PART NO.	TUBE SIZE	NPT THREAD	C1	L	M	N
SBMB6-1/8	6	1/8	12	48	24.0	18
SBMB6-1/4	6	1/4	12	50	25.0	23
SBMB8-1/8	8	1/8	14	52	26.0	19
SBMB8-1/4	8	1/4	14	52	26.0	23
SBMB10-1/4	10	1/4	17	56	28.0	24
SBMB10-3/8	10	3/8	17	56	28.0	24
SBMB12-3/8	12	3/8	19	63	31.5	25
SBMB12-1/2	12	1/2	19	63	31.5	31
SBMB14-3/8	14	3/8	22	63	31.5	28
SBMB14-1/2	14	1/2	22	65	32.5	31
SBMB16-1/2	16	1/2	27	69	34.5	34

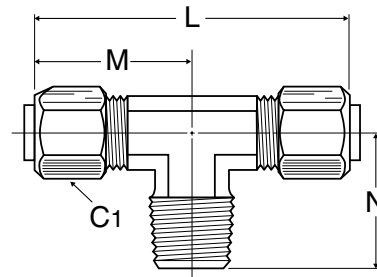

**S3BMB Male Branch Tee BSPT**

PART NO.	TUBE SIZE	BSPT THREAD	C1	L	M	N
S3BMB6-1/8	6	1/8	12	48	24.0	18
S3BMB6-1/4	6	1/4	12	49	24.5	23
S3BMB8-1/8	8	1/8	14	52	26.0	19
S3BMB8-1/4	8	1/4	14	52	26.0	23
S3BMB10-1/4	10	1/4	17	54	27.0	24
S3BMB10-3/8	10	3/8	17	56	28.0	24
S3BMB12-3/8	12	3/8	19	63	31.5	27
S3BMB12-1/2	12	1/2	19	63	31.5	31
S3BMB14-3/8	14	3/8	22	63	31.5	28
S3BMB14-1/2	14	1/2	22	65	32.5	31
S3BMB16-1/2	16	1/2	27	69	34.5	34

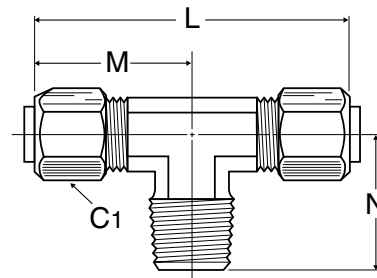

**KBMB Union Cross**

PART NO.	TUBE SIZE	C1	L	M
KBMB6	6	12	48	24.0
KBMB8	8	14	52	26.0
KBMB10	10	17	54	27.0
KBMB12	12	19	63	31.5
KBMB14	14	22	65	32.5

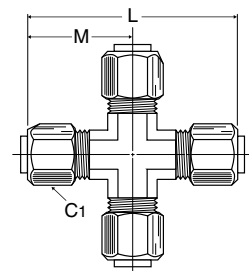

**COR4BMB Single Banjo BSPP**

PART NO.	TUBE SIZE	BSPP THREAD	C1	C5	M	N	N1
COR4BMB4-1/8	4	1/8	10	14	23	15	27
COR4BMB6-1/4	6	1/4	12	19	26	18	29
COR4BMB8-1/4	8	1/4	14	19	27	20	35
COR4BMB14-1/2	14	1/2	22	27	34	27	48
COR4BMB16-1/2	16	1/2	27	27	33	27	48
COR4BMB18-1/2	18	1/2	30	27	38	29	54
COR4BMB20-3/4	20	3/4	32	32	41	33	60
COR4BMB22-3/4	22	3/4	36	32	43	38	70

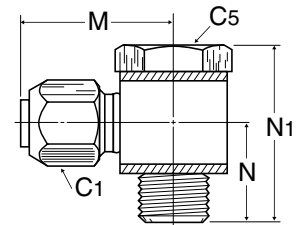

**A**

**T2HFB Tube End Male Adapter NPT**

PART NO.	TUBE SIZE	NPT THREAD	C HEX	L
T2HFB6-1/8	6	1/8	11	31
T2HFB6-1/4	6	1/4	14	36
T2HFB8-1/8	8	1/8	11	32
T2HFB8-1/4	8	1/4	14	36
T2HFB10-1/4	10	1/4	14	37
T2HFB10-3/8	10	3/8	19	38
T2HFB12-3/8	12	3/8	19	38
T2HFB12-1/2	12	1/2	22	43
T2HFB14-3/8	14	3/8	19	39
T2HFB14-1/2	14	1/2	22	44
T2HFB16-1/2	16	1/2	22	46
T2HFB18-1/2	18	1/2	22	50
T2HFB20-3/4	20	3/4	27	51
T2HFB22-3/4	22	3/4	27	54

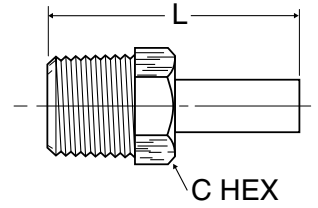

**T23HFB Tube End Male Adapter BSPT**

PART NO.	TUBE SIZE	BSPT THREAD	C HEX	L
T23HFB6-1/8	6	1/8	10	30
T23HFB6-1/4	6	1/4	14	34
T23HFB8-1/8	8	1/8	10	30
T23HFB8-1/4	8	1/4	14	35
T23HFB10-1/4	10	1/4	14	36
T23HFB10-3/8	10	3/8	17	36
T23HFB12-3/8	12	3/8	17	37
T23HFB12-1/2	12	1/2	22	40
T23HFB14-3/8	14	3/8	17	38
T23HFB14-1/2	14	1/2	22	41
T23HFB16-1/2	16	1/2	22	43
T23HFB18-1/2	18	1/2	22	47
T23HFB20-3/4	20	3/4	27	49
T23HFB22-3/4	22	3/4	27	51

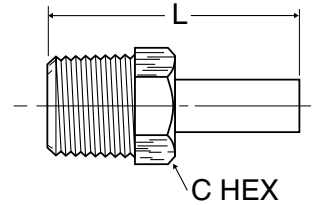

**T28HFB Tube Adapter Metric Straight Thread**

PART NO.	TUBE SIZE	MM THREAD	C HEX	L
T28HFB12M14	12	M14x1.5	19	39
T28HFB12M16	12	M16x1.5	22	40
T28HFB12M18	12	M18x1.5	24	40
T28HFB12M22	12	M22x1.5	27	43
T28HFB14M16	14	M16x1.5	22	41
T28HFB14M22	14	M22x1.5	27	44
T28HFB16M16	16	M16x1.5	22	43
T28HFB16M18	16	M18x1.5	24	43
T28HFB16M22	16	M22x1.5	27	46

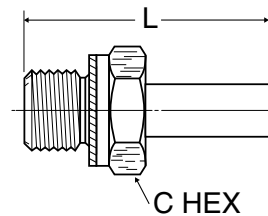

**A**

**T2HGB Tube End Female Adapter NPT**

PART NO.	TUBE SIZE	NPT THREAD	C HEX	L
T2HGB6-1/8	6	1/8	14	32
T2HGB6-1/4	6	1/4	19	35
T2HGB8-1/8	8	1/8	14	33
T2HGB8-1/4	8	1/4	19	36
T2HGB10-1/4	10	1/4	19	37
T2HGB10-1/2	10	1/2	27	41
T2HGB12-3/8	12	3/8	22	39
T2HGB12-1/2	12	1/2	27	41
T2HGB14-3/8	14	3/8	22	40
T2HGB14-1/2	14	1/2	27	42
T2HGB16-1/2	16	1/2	27	44
T2HGB18-1/2	18	1/2	27	48
T2HGB20-3/4	20	3/4	32	49
T2HGB22-3/4	22	3/4	32	51

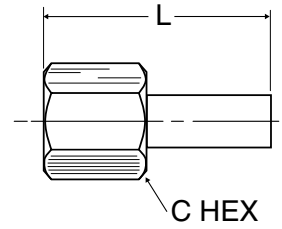

**T24HGB Tube End Female Adapter BSPP**

PART NO.	TUBE SIZE	BSPP THREAD	C HEX	L
T24HGB6-1/8	6	1/8	14	30
T24HGB6-1/4	6	1/4	19	32
T24HGB8-1/8	8	1/8	14	31
T24HGB8-1/4	8	1/4	19	33
T24HGB10-1/4	10	1/4	19	34
T24HGB10-3/8	10	3/8	22	36
T24HGB12-3/8	12	3/8	22	36
T24HGB12-1/2	12	1/2	27	40
T24HGB14-3/8	14	3/8	22	37
T24HGB14-1/2	14	1/2	27	41
T24HGB16-1/2	16	1/2	27	42
T24HGB18-1/2	18	1/2	27	46
T24HGB20-3/4	20	3/4	32	47
T24HGB22-3/4	22	3/4	32	49

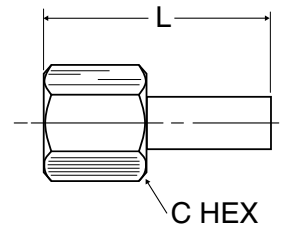

**BMB Nut**

PART NO.	TUBE SIZE	C1	L
BMB4	4	10	11
BMB6	6	12	12
BMB8	8	14	13
BMB10	10	17	13
BMB12	12	19	14
BMB14	14	22	15
BMB16	16	27	15
BMB18	18	30	19
BMB20	20	32	19
BMB22	22	36	20



**A**

**BTMB Nut and Ferrule**

PART NO.	TUBE SIZE	C1	L
BTMB4	4	10	12
BTMB6	6	12	13
BTMB8	8	14	14
BTMB10	10	17	14
BTMB12	12	19	15
BTMB14	14	22	16
BTMB16	16	27	16
BTMB18	18	30	21
BTMB20	20	32	21
BTMB22	22	36	22

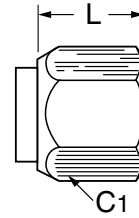

**FNMB Fitting Body Cap**

PART NO.	TUBE SIZE	C1	L
FNMB4	4	10	14
FNMB6	6	12	15
FNMB8	8	14	16
FNMB10	10	17	16
FNMB12	12	19	17
FNMB14	14	22	18
FNMB16	16	27	18
FNMB18	18	30	23
FNMB20	20	32	23
FNMB22	22	36	24

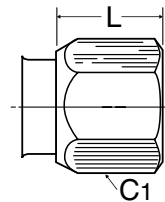

**PNMB Tube Plug**

PART NO.	TUBE SIZE	C HEX	L
PNMB4	4	8	11
PNMB6	6	10	13
PNMB8	8	12	15
PNMB10	10	14	15
PNMB12	12	17	16
PNMB14	14	19	17
PNMB16	16	22	18
PNMB18	18	24	20
PNMB20	20	27	20
PNMB22	22	30	22

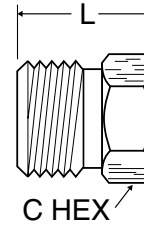

**TMB Ferrule**

PART NO.	TUBE SIZE	L
TMB4A	4	10
TMB6A	6	10
TMB8A	8	10
TMB10A	10	10
TMB12A	12	10
TMB14A	14	10
TMB16A	16	10
TMB18A	18	14
TMB20A	20	14
TMB22A	22	14

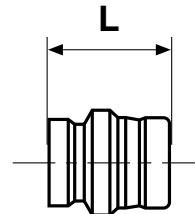

**A**

**TRBMB Tube End Reducer**

PART NO.	TUBE 1	TUBE 2	C1	L
TRBMB6-4	6	4	12	14
TRBMB8-4	8	4	14	15
TRBMB8-6	8	6	14	15
TRBMB10-6	10	6	17	16
TRBMB10-8	10	8	17	16
TRBMB12-8	12	8	19	16
TRBMB12-10	12	10	19	16
TRBMB14-10	14	10	22	18
TRBMB14-12	14	12	22	18
TRBMB16-12	16	12	27	19
TRBMB16-14	16	14	27	19
TRBMB18-14	18	14	30	21
TRBMB20-16	20	16	32	21
TRBMB22-18	22	18	36	21

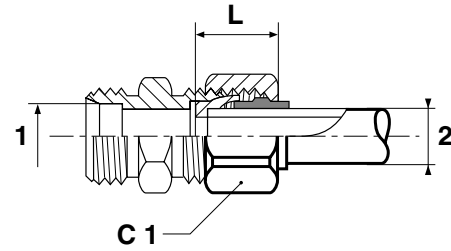

**T23UB Tube Insert**

PART NO.	TUBE I.D.	TUBE O.D.	L
T23UB4	4	6	10
T23UB6	6	8	15
T23UB8	8	10	15
T23UB10	10	12	15
T23UB12	12	14	15

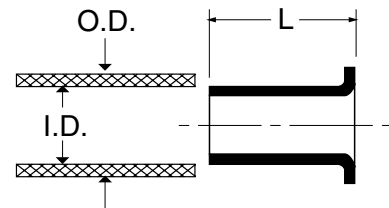

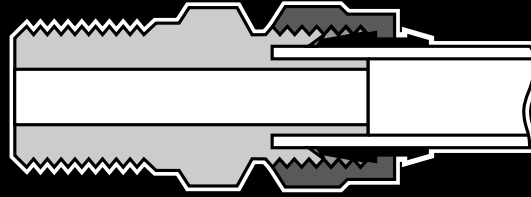

## Poly-Tite Fittings

### Advantages

A compact brass compression fitting designed to speed any installation. Body, nut and sleeve are furnished pre-assembled, ready for installation. An exclusive acetal copolymer sleeve holds plastic tubing where it belongs, even when the system pressure exceeds the tubing burst point. Poly-Tite sleeves have superior resilience to resist creeping and stress caused from compression. The black acetal copolymer sleeve also resists ultra-violet ray attack and has excellent dimensional stability. Poly-Tite nuts will rotate around the sleeve as it tightens to prevent twisting and weakening of the plastic tubing. Poly-Tite fittings can be assembled and disassembled repeatedly.

### Materials

Bodies and Nuts: CA 377, CA 360, CA 345, 316 Stainless Steel

Plastic Sleeves: Acetal Copolymer.

O-rings: Buna N on chrome plated couplings  
Viton on stainless steel couplings

### Applications

Use with Parker Parflex® or other high-quality thermoplastic tubing for pneumatic instrumentation circuits, lubricant and coolant lines, and applications with other gases and liquids. For use with soft metal tubing and nylon thermoplastic tubing, use brass sleeve and nut assembly 61PB.

### Working Pressure and Temperature Ranges

Up to 150 PSI from 0° to +150°F with thermoplastic tubing. Up to 300 PSI from 0° to +175°F with soft metal tubing.

### Assembly Instructions

#### Polyethylene, polypropylene and vinyl tubing:

1. Cut tubing squarely—maximum of 15° angle allowable.
2. Check that port or mating part is clean and free of debris.
3. Insert tube end until it bottoms in the Poly-Tite fitting and tighten knurl/hex nut finger-tight — plus one wrench turn.

#### Copper, aluminum and nylon tubing:

Brass sleeves are recommended. Insert tube until it bottoms in the Poly-Tite fitting and tighten one wrench turn past finger-tight.

#### Maximum allowable metal tube wall thickness for use with Poly-Tite fittings:

1/8", 3/16" O.D. — no limitation, 1/4" O.D. — .035  
5/16", 3/8", 1/2" O.D. — .049

### Order

By part number and name.

### Nomenclature

Part numbers are constructed from symbols that identify the style and size of the fitting. The first series of numbers and letters identifies the style and type fitting. The second series of numbers describes the size.

**Example:**                    66                    P                    -4                    -2

Female Connector ————|  
(Tube to female pipe)  
Poly-Tite ————|  
1/4" (4/16) Tube O.D. ————|  
1/8" (2/16) Pipe Thread ————|

### Sizes

Tube sizes are determined by the number of sixteenths of an inch in the tube O.D.

### Special Fittings

Fitting configurations and/or sizes other than those shown in the catalog can be furnished. It is suggested that a print or sketch be submitted with the inquiry.

### Pricing

Only items priced in current supplementary price list PL3501 are carried in stock. Price and delivery for nonstock items furnished on request for specified quantity.

### Tube Support O.D.

Tube Size Inches	* D1 Tube Support O.D.
1/4	.168
5/16	.185
3/8	.248
1/2	.373

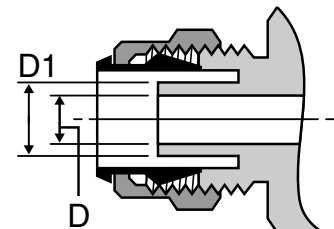

\* Note: No tube support for sizes 1/8" and 3/16"



**Spring Guard 56PSG**

PART NO.	TUBE O.D.	L
56PSG-4	1/4	3.000
56PSG-5	5/16	3.000
56PSG-6	3/8	3.000

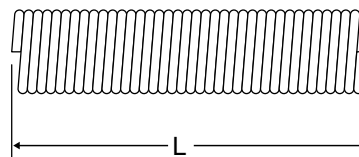

**Plastic Cap 59P**

PART NO.	TUBE SIZE	A	L
59P-4	1/4	.247	.50
59P-5	5/16	.307	.53
59P-6	3/8	.372	.56
59P-8	1/2	.497	.63



**Acetal Plastic Sleeve 60P**

PART NO.	TUBE SIZE	A	D	L
60P-4	1/4	.334	.261	.338
60P-5	5/16	.405	.321	.340
60P-6	3/8	.465	.381	.367
60P-8	1/2	.628	.514	.399

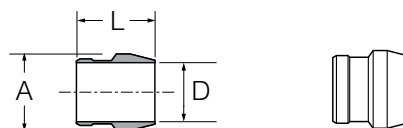

**Sleeve 60PB**

PART NO.	L	O.D.	I.D.
60PB-2	.187	.265	.130
60PB-3	.187	.322	.192
60PB-4	.187	.336	.255
60PB-5	.187	.400	.318
60PB-6	.218	.460	.382
60PB-8	.250	.620	.507

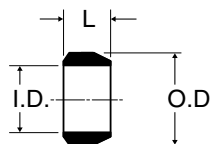

**Nut and Plastic Sleeve Assembly 61P**

PART NO.	TUBE SIZE	STRAIGHT THREAD	C HEX	D	L
61P-2*	1/8	5/16-24	3/8	.130	.34
61P-3*	3/16	3/8-24	7/16	.192	.37
61P-4	1/4	3/8-24	7/16	.261	.38
61P-5	5/16	7/16-24	1/2	.321	.34
61P-6	3/8	1/2-24	9/16	.380	.38
61P-8	1/2	11/16-20	3/4	.514	.44

\* Brass Sleeve

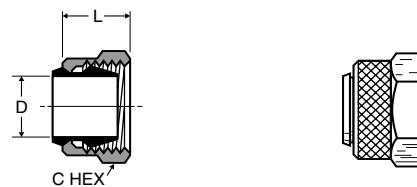

**Nut and Brass Sleeve Assembly 61PB**

PART NO.	TUBE SIZE	STRAIGHT THREAD	C HEX	D	L
61PB-4	1/4	3/8-24	7/16	.255	.38
61PB-5	5/16	7/16-24	1/2	.318	.34
61PB-6	3/8	1/2-24	9/16	.382	.38
61PB-8	1/2	11/16-20	3/4	.507	.44

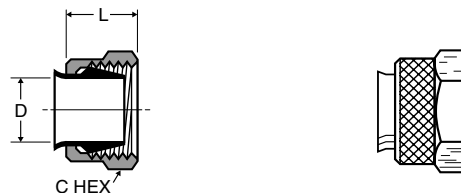

**Nut 61PN**

PART NO.	TUBE SIZE	STRAIGHT THREAD	C HEX	L
61PN-2	1/8	5/16-24	3/8	.34
61PN-3	3/16	3/8-24	7/16	.37
61PN-4	1/4	3/8-24	7/16	.38
61PN-5	5/16	7/16-24	1/2	.34
61PN-6	3/8	1/2-24	9/16	.38
61PN-8	1/2	11/16-20	3/4	.44

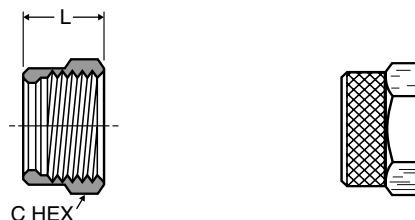

**A**

**Nut only for use with Spring Gaurd 61PSGN**

PART NO.	TUBE O.D.	L	C HEX
61PSGN-4	1/4	.625	.437
61PSGN-5	5/16	.625	.500
61PSGN-6	3/8	.656	.562

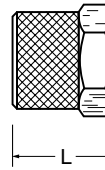

**Union 62P**

PART NO.	TUBE SIZE	STRAIGHT THREAD	C HEX	L	M	FLOW DIA. D
62P-2*	1/8	5/16-24	5/16	1.08	.64	.094
62P-3*	3/16	3/8-24	3/8	1.16	.73	.125
62P-4	1/4	3/8-24	3/8	1.17	.96	.125
62P-5	5/16	7/16-24	7/16	1.16	.96	.144
62P-6	3/8	1/2-24	1/2	1.23	.99	.204
62P-8	1/2	11/16-20	11/16	1.47	1.24	.323

\* Brass Sleeve, No Tube Support

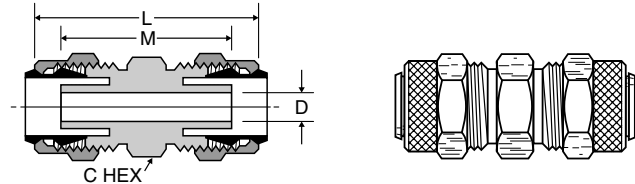

**Union Reducer 62P**

PART NO.	1 TUBE SIZE	2 TUBE SIZE	1 STRAIGHT THREAD	2 STRAIGHT THREAD	C HEX	L	M	FLOW DIA. D
62P-6-4	1/4	3/8	3/8-24	1/2-24	1/2	1.22	.99	.125

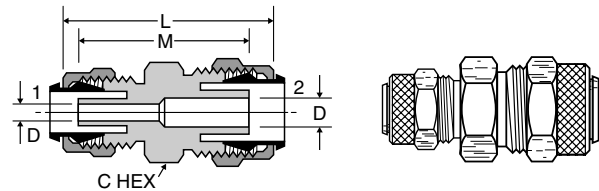

**Bulkhead Union 62PBH**

PART NO.	TUBE SIZE	STRAIGHT THREAD	C HEX	P MAX.	L	M	BULKHEAD HOLE DIA.	FLOW DIA. D
62PBH-4	1/4	3/8-24	9/16	.38	1.75	1.53	3/8	.125
62PBH-5	5/16	7/16-24	5/8	.38	1.71	1.52	7/16	.144
62PBH-6	3/8	1/2-24	11/16	.47	1.89	1.65	1/2	.204
62PBH-8	1/2	11/16-20	7/8	.63	2.28	2.05	11/16	.323

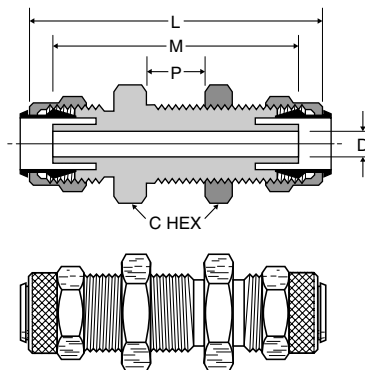

**Union 62PCA**

(Tube to Compress-Align)

PART NO.	TUBE SIZE	1 STRAIGHT THREAD	2 STRAIGHT THREAD	C HEX	L	M	FLOW DIA. D
62PCA-4	1/4	3/8-24	7/16-24	7/16	1.25	.89	.125
62PCA-5	5/16	7/16-24	1/2-24	1/2	1.30	.92	.144
62PCA-6	3/8	1/2-24	9/16-24	9/16	1.37	.98	.204

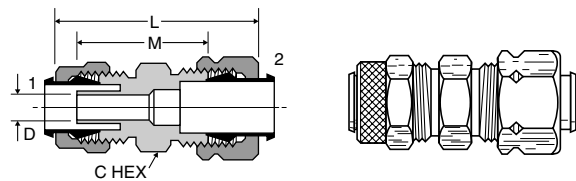





**Bulkhead Union 62PCABH**

(Tube to Compress-Align)

PART NO.	TUBE SIZE	1 STRAIGHT THREAD	2 STRAIGHT THREAD	C HEX	P MAX	L	M	BULKHEAD HOLE DIA.	FLOW DIA. D
62PCABH-4	1/4	3/8-24	7/16-24	9/16	.38	1.81	1.45	3/8	.125
62PCABH-6	3/8	1/2-24	9/16-24	11/16	.47	2.03	1.64	1/2	.204

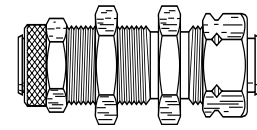
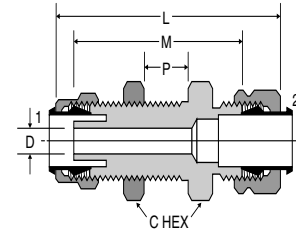

**Bulkhead Union 62PTBH**

(Straight Through)

PART NO.	TUBE SIZE	STRAIGHT THREAD	C HEX	P MAX.	L	M	BULKHEAD HOLE DIA.	FLOW DIA. D
62PTBH-4	1/4	3/8-24	9/16	.31	1.19	.93	3/8	.260
62PTBH-5	5/16	7/16-24	5/8	.31	1.19	.93	7/16	.323
62PTBH-6	3/8	1/2-24	11/16	.34	1.26	.99	1/2	.387

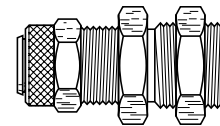
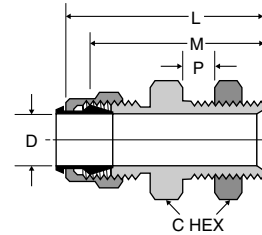

**Brass Insert 63PT**

PART NO.	TUBE SIZE	L	O.D.
63PT-2-16	1/8	.46	.080
63PT-2-32	1/8	.31	.061
63PT-3-25	3/16	.45	.135
63PT-3-40	3/16	.52	.095

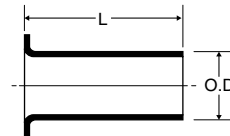

**Female Connector 66P**

PART NO.	TUBE SIZE	PIPE THREAD	STRAIGHT THREAD	C HEX	L	M	FLOW DIA. D
66P-2-2*	1/8	1/8	5/16-24	9/16	.97	.75	.094
66P-3-2*	3/16	1/8	3/8-24	9/16	1.00	.78	.125
66P-3-4*	3/16	1/4	3/8-24	11/16	1.18	.96	.125
66P-4-2	1/4	1/8	3/8-24	1/2	.97	.86	.125
66P-4-4	1/4	1/4	3/8-24	5/8	1.18	1.07	.125
66P-5-2	5/16	1/8	7/16-24	1/2	.97	.86	.144
66P-6-4	3/8	1/4	1/2-24	5/8	1.18	1.07	.204
66P-8-6	1/2	3/8	11/16-20	13/16	1.31	1.20	.323

\*Brass Sleeve, No Tube Support

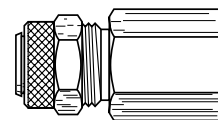
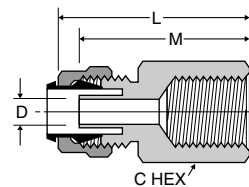

**A**

**Male Connector 68P**

PART NO.	TUBE SIZE	PIPE THREAD	STRAIGHT THREAD	C HEX	L	M	FLOW DIA. D
68P-2-1*	1/8	1/16	5/16-24	11/32	1.00	.78	.094
68P-2-10X32*	1/8	10-32	5/16-24	3/8	.86	.64	.094
68P-2-2*	1/8	1/8	5/16-24	7/16	.99	.77	.094
68P-3-1	3/16	1/16	3/8-24	7/16	1.09	.84	.094
68P-3-2*	3/16	1/8	3/8-24	7/16	1.06	.84	.125
68P-3-4*	3/16	1/4	3/8-24	9/16	1.25	1.03	.125
68P-4-1	1/4	1/16	3/8-24	3/8	1.06	.95	.125
68P-4-10X32	1/4	10-32	3/8-24	3/8	.86	.75	.094
68P-4-2	1/4	1/8	3/8-24	7/16	1.06	.95	.125
68P-4-4	1/4	1/4	3/8-24	9/16	1.25	1.14	.125
68P-4-6	1/4	3/8	3/8-24	11/16	1.28	1.17	.125
68P-5-2	5/16	1/8	7/16-24	7/16	1.05	.95	.144
68P-5-4	5/16	1/4	7/16-24	9/16	1.24	1.14	.144
68P-6-2	3/8	1/8	1/2-24	1/2	1.10	.98	.204
68P-6-4	3/8	1/4	1/2-24	9/16	1.29	1.17	.204
68P-6-6	3/8	3/8	1/2-24	11/16	1.29	1.17	.204
68P-8-4	1/2	1/4	11/16-20	11/16	1.46	1.29	.320
68P-8-6	1/2	3/8	11/16-20	11/16	1.37	1.29	.323

\*Brass Sleeve, No Tube Support

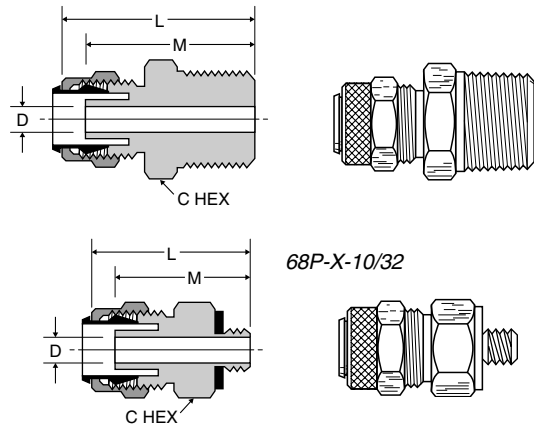

**Tube End Reducer 97P**

PART NO.	TUBE O.D.	L	M	C HEX
97P-4-6	3/8 X 1/4	1.718	1.625	.437
97P-6-8	1/2 X 3/8	1.875	1.781	.562

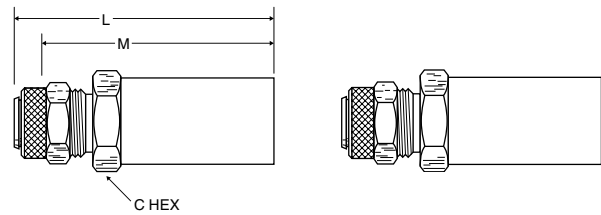

**Pipe Coupler Body 391P**

(Chrome Plated)

PART NO.	D-INSERT DIA.	PIPE THREAD	C HEX	H	L
391P-4-2	1/4	1/8	1/2	.91	1.29
391P-4-4	1/4	1/4	9/16	.73	1.29
391P-6-4	3/8	1/4	5/8	.85	1.41

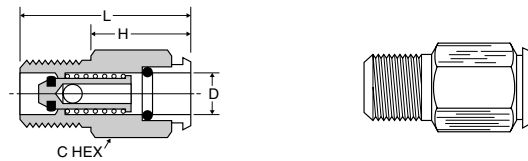

**Pipe Coupler Body 391PSS**

(Stainless Steel)

PART NO.	D INSERT DIA.	PIPE THREAD	L	C HEX	M
391PSS-4-2	1/4	1/8	1.271	.500	.900
391PSS-4-4	1/4	1/4	1.271	.562	.710
391PSS-6-4	3/8	1/4	1.40	.625	.840

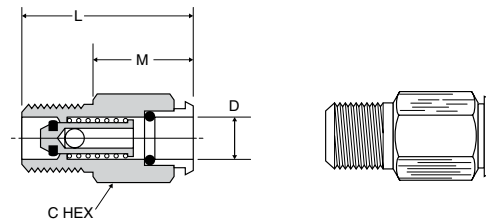



**Bulkhead Coupler Body 392P**

(Chrome Plated)

PART NO.	TUBE SIZE	D-INSERT DIA.	STRAIGHT THREAD	C HEX	P MAX.	H	L	BULKHEAD HOLE DIA.
392P-4-4	1/4	1/4	1/2-24	5/8	.84	.39	2.13	1/2
392P-6-6	3/8	3/8	11/16-24	13/16	.93	.37	2.01	11/16

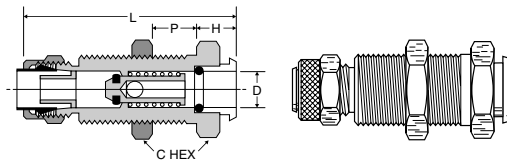

**Bulkhead Coupler Body 392PSS**

(Stainless Steel)

PART NO.	TUBE O.D.	BULKHEAD THREAD	L	C HEX	H	P MAX.	BULKHEAD HOLE DIA.
392PSS-4-4	1/4	1/2-24	2.03	.625	.28	.84	1/2
392PSS-6-6	3/8	11/16-24	2.20	.812	.31	.93	11/16

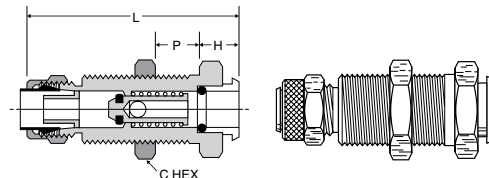

**Through Type Insert 393P**

(Chrome Plated)

PART NO.	TUBE SIZE	D-INSERT DIA.	STRAIGHT THREAD	C SQUARE	H	FLOW DIA.F
393P-4-4	1/4	1/4	3/8-24	7/16	1.12	.125
393P-6-6	3/8	3/8	1/2-24	1/2	1.34	.203

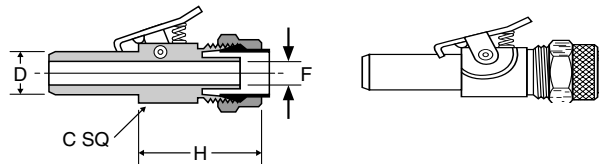

**Through Type Insert 393PSS**

(Stainless Steel)

PART NO.	TUBE O.D.	D-INSERT DIA.	L	C SQUARE	H	FLOW DIA.F
393PSS-4-4	1/4	1/4	1.677	.500	.99	.125
393PSS-6-6	3/8	3/8	2.030	.500	1.27	.203

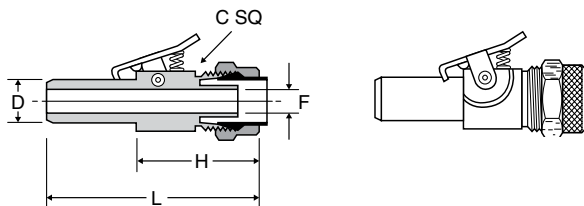

**Shutoff Type Insert 393PD**

(Chrome Plated)

PART NO.	TUBE SIZE	D-INSERT DIA.	STRAIGHT THREAD	C SQUARE	H	FLOW DIA.F
393PD-4-4	1/4	1/4	3/8-24	7/16	1.61	.110
393PD-6-6	3/8	3/8	1/2-24	1/2	1.45	.187

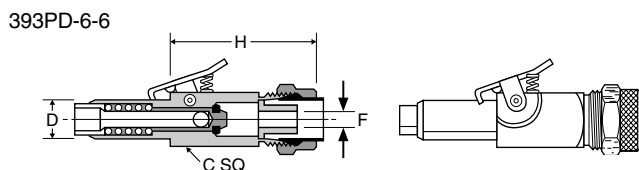
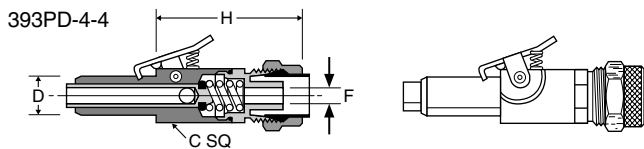

**A**

**Shut-Off Type Insert 393PDSS**

(Stainless Steel)

PART NO.	TUBE O.D.	D-INSERT DIA.	L	C SQUARE	H	FLOW DIA.F
393PDSS-4-4	1/4	1/4	2.46	.500	1.62	.116
393PDSS-6-6	3/8	3/8	2.60	.500	1.67	.157

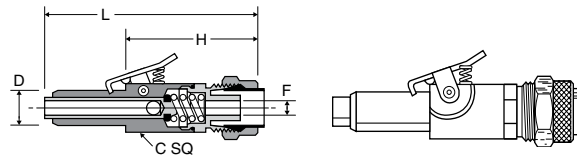

**Single End Shutoff Bulkhead Quick Coupler 394P**

(Chrome Plated)

PART NO.	TUBE SIZE	STRAIGHT THREAD	C HEX	P MAX.	H	L	M	BULKHEAD HOLE DIA.	FLOW DIA.F
394P-4-4	1/4	1/2-24	5/8	.84	.39	3.28	2.13	1/2	.125
394P-6-6	3/8	11/16-24	13/16	.93	.37	3.41	2.01	11/16	.203

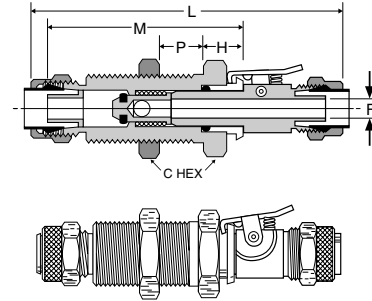

**Coupler Single End Shut-Off Bulkhead 394PSS**

(Stainless Steel)

PART NO.	TUBE O.D.	BULKHEAD THREAD	L	M	C HEX	H	P MAX.	FLOW DIA. F
394PSS-4-4	1/4	1/2-24	3.05	2.06	.625	.31	.84	.125
394PSS-6-6	3/8	11/16-24	3.50	2.23	.812	.34	.93	.203

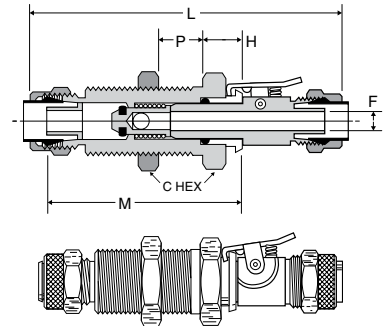

**Double End Shutoff Bulkhead Quick Coupler 394PD**

(Chrome Plated)

PART NO.	TUBE SIZE	STRAIGHT THREAD	C HEX	P MAX.	H	L	M	BULKHEAD HOLE DIA.	FLOW DIA.F
394PD-4-4	1/4	1/2-24	5/8	.84	.39	3.77	2.13	1/2	.125
394PD-6-6	3/8	11/16-24	13/16	.93	.37	3.48	2.01	11/16	.204

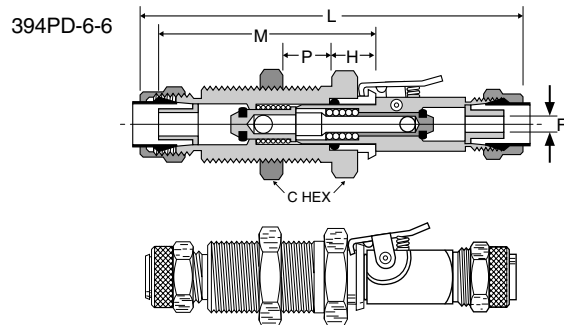
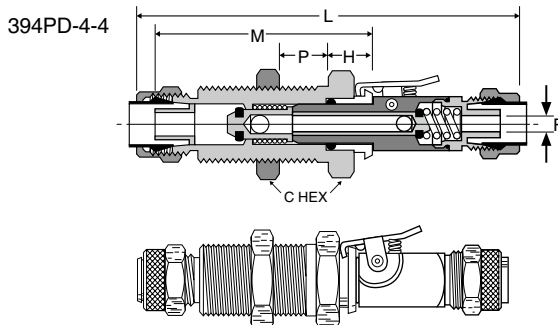



**Double End Shut-Off Bulkhead Quick Coupler 394PDSS**

(Stainless Steel)

PART NO.	TUBE O.D.	BULKHEAD THREAD	L	M	C HEX	H	P MAX	FLOW DIA. F
394PDSS-4-4	1/4	1/2-24	3.69	2.67	.625	.32	.84	.125
394PDSS-6-6	3/8	11/16-24	3.91	2.24	.812	.34	.93	.203

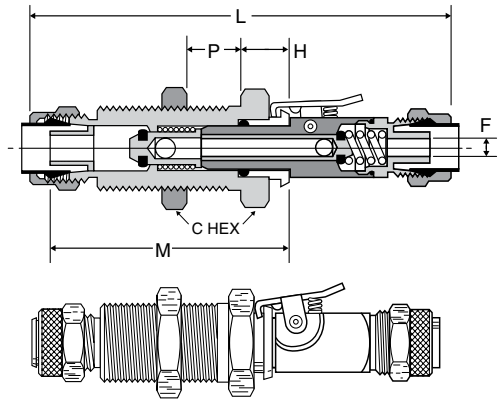

**Single End Shutoff Pipe Connector Quick Coupler 398P**

(Chrome Plated)

PART NO.	TUBE SIZE	PIPE THREAD	STRAIGHT THREAD	C HEX	L	M	FLOW DIA.F
398P-4-2	1/4	1/8	3/8-24	1/2	2.45	1.32	.125
398P-4-4	1/4	1/4	3/8-24	9/16	2.45	1.32	.125
398P-6-4	3/8	1/4	1/2-24	5/8	2.80	1.46	.203

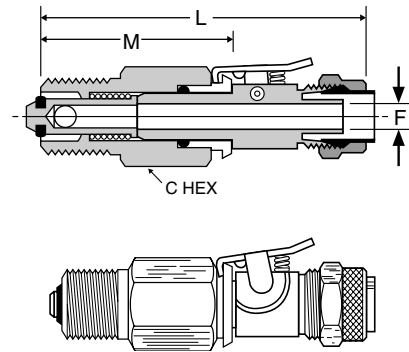

**Single End Shut-Off Connector Quick Coupler 398PSS**

(Stainless Steel)

PART NO.	TUBE O.D.	PIPE THREAD	L	M	C HEX	FLOW DIA. F
398PSS-4-2	1/4	1/8	2.30	1.32	.500	.125
398PSS-4-4	1/4	1/4	2.30	1.32	.562	.125
398PSS-6-4	3/8	1/4	2.70	1.43	.625	.203

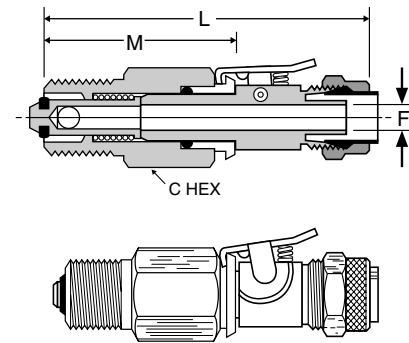

**A**

**Double End Shutoff Pipe Connector Quick Coupler 398PD**

(Chrome Plated)

PART NO.	TUBE SIZE	PIPE THREAD	STRAIGHT THREAD	C HEX	L	M	FLOW DIA.F
398PD-4-2	1/4	1/8	3/8-24	1/2	2.93	1.31	.125
398PD-4-4	1/4	1/4	3/8-24	9/16	2.93	1.32	.125
398PD-6-4	3/8	1/4	1/2-24	5/8	2.88	1.43	.204

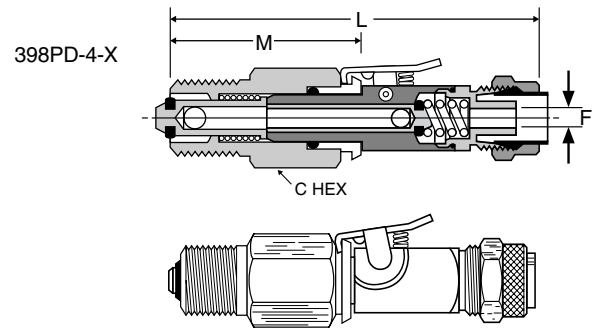
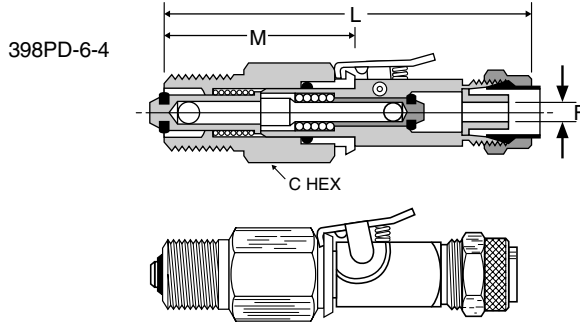

**Double End Shut-Off Pipe Connector Quick Coupler 398PDSS**

(Stainless Steel)

PART NO.	TUBE O.D.	PIPE THREAD	L	M	C HEX	FLOW DIA. D
398PDSS-4-2	1/4	1/8	2.93	1.31	.500	.125
398PDSS-4-4	1/4	1/4	2.93	1.31	.562	.125
398PDSS-6-4	3/8	1/4	3.10	1.43	.625	.125

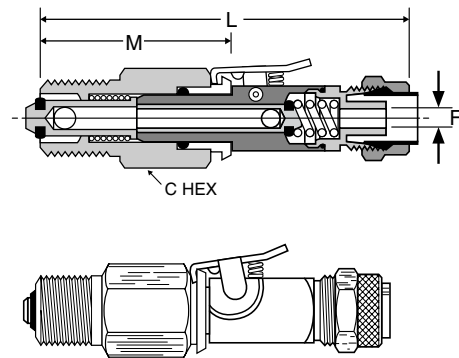

**Union Tee 164P**

PART NO.	TUBE SIZE	STRAIGHT THREAD	L	M	FLOW DIA.D
164P-2*	1/8	5/16-24	.83	.61	.094
264P-3*	3/16	3/8-24	.83	.61	.125
164P-4	1/4	3/8-24	.84	.73	.125
164P-5	5/16	7/16-24	.83	.73	.144
164P-6	3/8	1/2-24	.98	.86	.203
164P-8	1/2	1 1/16-20	1.12	1.04	.323

\*Brass Sleeve, No Tube Support

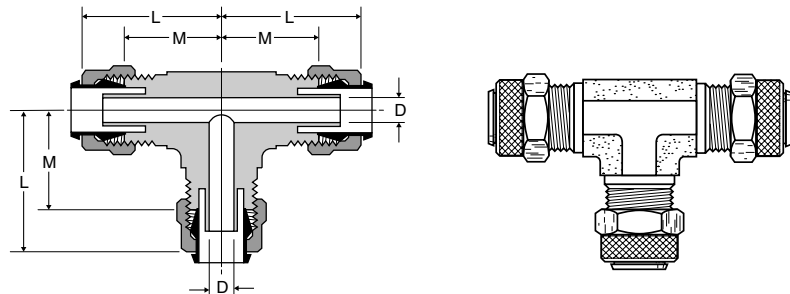



**Union Tee 164P combination size**

PART NO.	1 TUBE SIZE	2 TUBE SIZE	3 TUBE SIZE	L	L1	M	M1	FLOW DIA.D
164P-6-4	3/8	3/8	1/4	.98	.90	.86	.79	.125

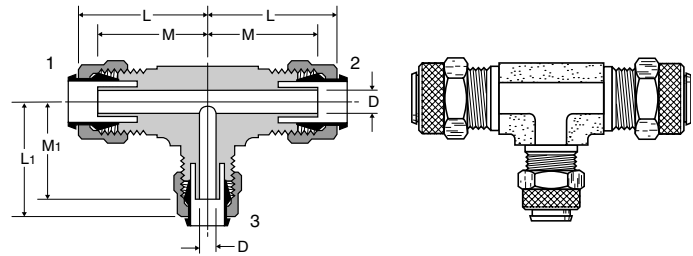

**Male Elbow 169P/269P**

PART NO.	TUBE SIZE	PIPE THREAD	STRAIGHT THREAD	L	M	N	FLOW DIA.D
169P-2-1	1/8	1/16	5/16-24	.88	.63	.69	.094
269P-2-2*	1/8	1/8	5/16-24	.83	.61	.67	.094
169P-3-1	3/16	1/16	3/8-24	.88	.63	.69	.094
169P-3-2*	3/16	1/8	3/8-24	.83	.61	.69	.125
169P-3-4*	3/16	1/4	3/8-24	.85	.63	.94	.125
169P-4-1	1/4	1/16	3/8-24	.92	.58	.67	.130
169P-4-2	1/4	1/8	3/8-24	.84	.73	.75	.121
169P-4-4	1/4	1/4	3/8-24	.90	.79	.92	.125
169P-4-6	1/4	3/8	3/8-24	.93	.84	1.08	.125
169P-5-2	5/16	1/8	7/16-24	.87	.73	.68	.144
169P-6-2	3/8	1/8	1/2-24	.93	.81	.73	.203
169P-6-4	3/8	1/4	1/2-24	.98	.86	1.05	.203
169P-6-6	3/8	3/8	1/2-24	.98	.86	1.08	.203
169P-8-6	1/2	3/8	11/16-20	1.12	1.04	1.13	.323

\*Brass Sleeve, No Tube Support

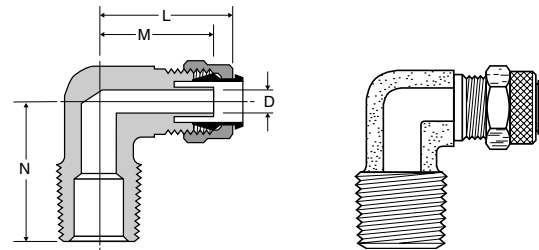

**Long Male Elbow 169LP**

PART NO.	TUBE SIZE	PIPE THREAD	STRAIGHT THREAD	L	M	N	FLOW DIA.D
169LP-4-4	1/4	1/4	3/8-24	.90	.79	1.38	.125

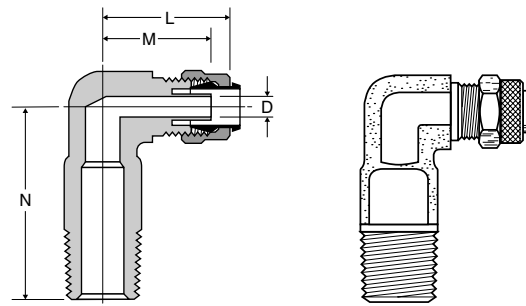

**Male Elbow Swivel 169PS**

PART NO.	TUBE O.D.	PIPE THREAD	A	B	C HEX	D	E
169PS-4-2	1/4	1/8	.812	.594	.375	.862	.437
169PS-4-4	1/4	1/4	.906	.688	.562	1.218	.562
169PS-6-2	3/8	1/8	.875	.625	.437	.904	.437
169PS-6-4	3/8	1/4	.937	.685	.562	1.218	.562
169PS-6-6	3/8	3/8	.859	.602	.562	1.190	.687
169PS-8-6	1/2	3/8	1.031	.782	.500	1.218	.687

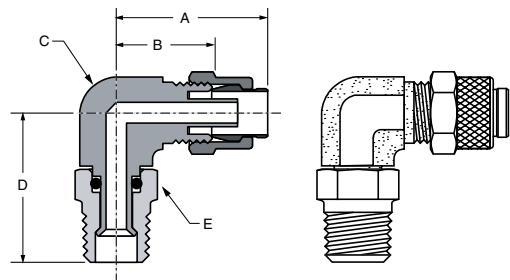

**A**

**Female Elbow 170P**

PART NO.	TUBE SIZE	PIPE THREAD	STRAIGHT THREAD	L	M	N	FLOW DIA.D
170P-2-2*	1/8	1/8	5/16-24	.91	.69	.56	.094
170P-3-2*	3/16	1/8	3/8-24	.91	.69	.56	.125
170P-4-2	1/4	1/8	3/8-24	.90	.79	.56	.125
170P-4-4	1/4	1/4	3/8-24	1.00	.89	.69	.125
170P-6-4	3/8	1/4	1/2-24	1.01	.89	.69	.204
170P-8-6	1/2	3/8	11/16-20	1.19	1.11	1.13	.323

\*Brass Sleeve, No Tube Support

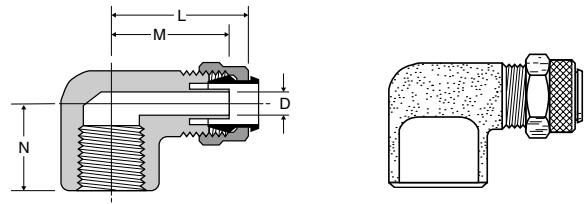

**Male Run Tee 171P**

PART NO.	TUBE SIZE	PIPE THREAD	STRAIGHT THREAD	L	M	N	FLOW DIA.D
171P-2-2*	1/8	1/8	5/16-24	.82	.60	.67	.094
171P-3-2*	3/16	1/8	3/8-24	.82	.60	.67	.125
171P-4-2	1/4	1/8	3/8-24	.84	.73	.72	.125
171P-4-4	1/4	1/4	3/8-24	.92	.81	.92	.125
171P-5-2	5/16	1/8	7/16-24	.83	.73	.72	.144
171P-6-4	3/8	1/4	1/2-24	.98	.86	1.03	.203
171P-8-6	1/2	3/8	11/16-20	1.12	1.04	1.13	.323

\*Brass Sleeve, No Tube Support

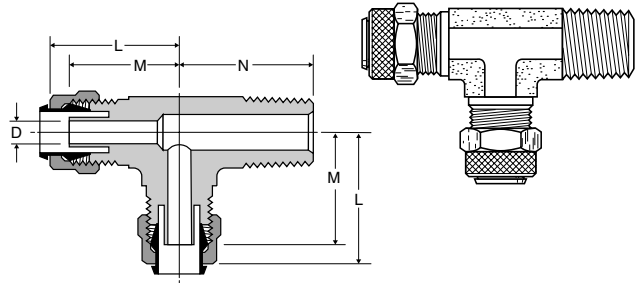

**Male Branch Tee 172P**

PART NO.	TUBE SIZE	PIPE THREAD	STRAIGHT THREAD	L	M	N	FLOW DIA.D
172P-2-2*	1/8	1/8	5/16-24	.82	.60	.67	.094
172P-3-2*	3/16	1/8	3/8-24	.82	.60	.67	.125
172P-4-2	1/4	1/8	3/8-24	.84	.73	.72	.125
172P-4-4	1/4	1/4	3/8-24	.92	.81	.92	.125
172P-5-2	5/16	1/8	7/16-24	.83	.73	.72	.144
172P-6-2	3/8	1/8	1/2-24	.88	.86	.74	.204
172P-6-4	3/8	1/4	1/2-24	.98	.86	1.03	.204
172P-8-6	1/2	3/8	11/16-20	1.12	1.04	1.13	.323

\*Brass Sleeve, No Tube Support

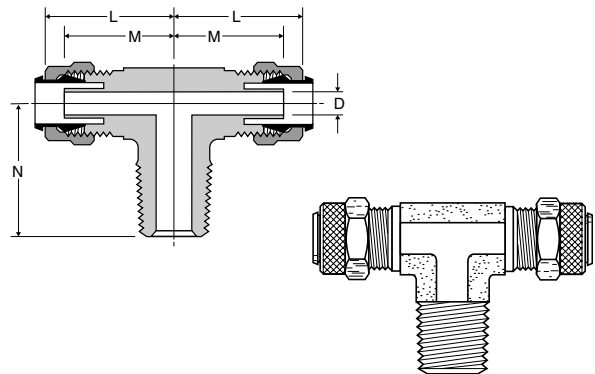

**Female Branch Tee 177P**

PART NO.	TUBE SIZE	PIPE THREAD	STRAIGHT THREAD	L	M	N	FLOW DIA.D
177P-4-2	1/4	1/8	3/8-24	.92	.81	.88	.125
177P-4-4	1/4	1/4	3/8-24	.92	.81	1.03	.125
177P-4-6	1/4	3/8	3/8-24	1.03	.92	1.13	.125

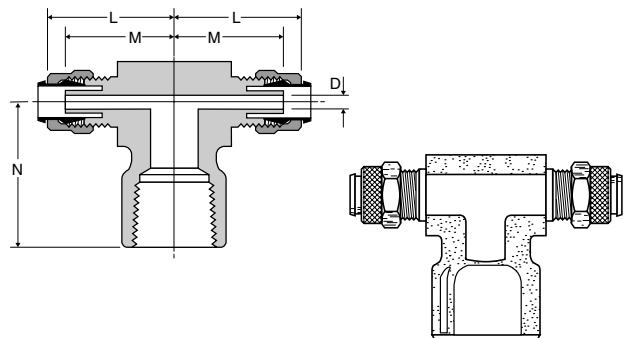





**Needle Valve NV311P**

PART NO.	TUBE SIZE	PIPE THREAD	H	L OPEN	L CLOSED	M	N
NV311P-4-2	1/4	1/8	1.06	1.36	1.16	.64	.63
NV311P-4-4	1/4	1/4	1.06	1.38	1.18	.64	.72
NV311P-6-4	3/8	1/4	1.06	1.38	1.18	.64	.72

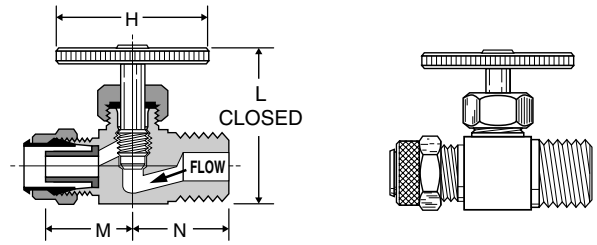

**Angle Needle Valve NV312P**

PART NO.	TUBE SIZE	PIPE THREAD	H	L OPEN	L CLOSED	M	N
NV312P-4-2	1/4	1/8	1.06	1.70	1.50	.63	.68
NV312P-4-4	1/4	1/4	1.06	2.07	1.82	.71	.86
NV312P-6-4	3/8	1/4	1.06	2.00	1.75	.74	.86

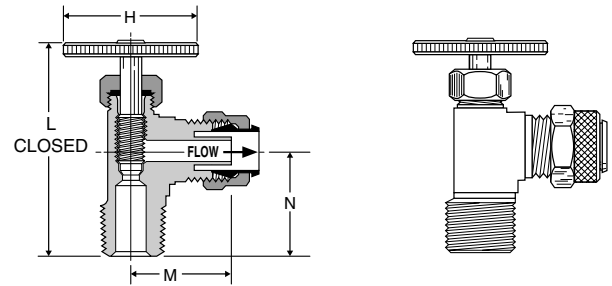

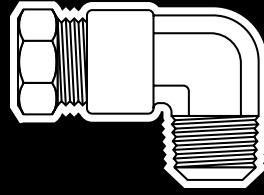

## Hi-Duty Flareless Tube Fittings

### Advantages

No flaring, soldering or other preparation of tubing is necessary. Pre-assembled brass fitting, with sleeve machined onto nut. This two piece flareless compression design is available in a broad selection of configurations from 1/8" through 5/8" OD. tube size.

### Applications

Use with copper, brass, seamless steel and thermoplastic tubing for instrumentation systems, farm and mobile construction equipment, hydraulic and pneumatic controls, process control systems and laboratory equipment.

Steel tubing must be cold drawn and annealed seamless low-carbon steel tubing per SAE J524 with a maximum hardness of Rockwell B 65. Brass insert 63PT is recommended for use with thermoplastic tubing.

### Working Pressure Range

Up to 4,300 psi depending on tubing being used

### Maximum Recommended Working Pressure

Tube O.D.	PSI
1/8	4,300
3/16	2,850
1/4	2,100
5/16	1,800
3/8	1,500
1/2	1,150
5/8	1,000

### Assembly Instructions

1. Cut tube squarely and cleanly removing all burrs.
2. Grasp fitting. Do not remove nut.
3. Insert tube in fitting through nut until tube seats firmly against tube shoulder in body.
4. Grip tube firmly to prevent turning and tighten nut to finger-tight. Continue to tighten nut for one and three-quarter additional turns (one and one-half turns for 1/2" size tube fittings) for a positive, leak proof seal. During tightening a slight "give" will be felt. This "give" indicates the sleeve has been sheared from the nut. It is not necessary to tighten the nut all the way down.

### To Reconnect:

1. Reinsert tubing
2. Tighten nut one-eighth of a turn more than previous make-up.

### Order

By part number and name.

### Nomenclature

Part numbers are constructed from symbols that identify the style and size of the fitting. The first series of numbers and letters identifies the style and type of fitting. The second series of numbers describes the size.

### Example:

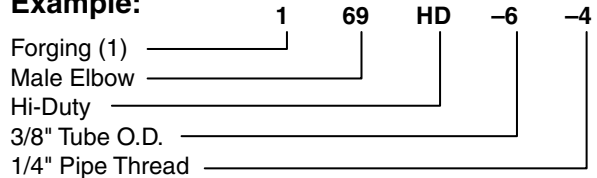

### Special Fittings

Fitting configurations and/or sizes other than those shown in the catalog can be furnished. It is suggested that a print or sketch be submitted with the inquiry.

### Pricing

Only items priced in current supplementary price list PL3501 are carried in stock. Price and delivery for non-stock items furnished on request for specified quantity.



**Bulkhead Union 62HDBH**

PART NO.	TUBE SIZE	MIN. ORIFICE SIZE	A	B	C	D	E
62HDBH-2	1/8	.093	1.781	1.156	.562	.625	7/16-24
62HDBH-4	1/4	.187	1.968	1.156	.687	.625	9/16-24

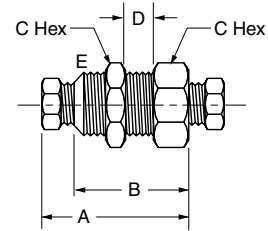

**Nut/Sleeve 61HD**

PART NO.	TUBE SIZE	PIPE THREAD	A	C
61HD-2	1/8	5/16-24	.656	.312
61HD-3	3/16	3/8-24	.687	.375
61HD-4	1/4	7/16-24	.734	.437
61HD-5	5/16	1/2-20	.765	.500
61HD-6	3/8	9/16-20	.843	.562
61HD-8	1/2	11/16-16	.921	.688
61HD-10	5/8	7/8-18	1.078	.875

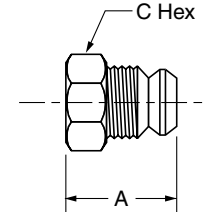

**Union 62HD**

PART NO.	TUBE SIZE	MIN. ORIFICE SIZE	A	B	C
62HD-2	1/8	.093	1.687	1.062	.375
62HD-3	3/16	.125	1.781	1.031	.437
62HD-4	1/4	.187	1.906	1.093	.562
62HD-6	3/8	.312	2.187	1.375	.625
62HD-8	1/2	.437	2.437	1.562	.812
62HD-10	5/8	.500	2.937	1.812	1.062

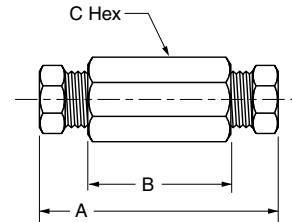

**Union Tee 164HD**

PART NO.	TUBE SIZE	MIN. ORIFICE SIZE	A	B	C HEX
164HD-4	1/4	.187	1.082	.687	.500
164HD-6	3/8	.312	1.357	.970	.562
164HD-8	1/2	.437	1.481	1.060	.750

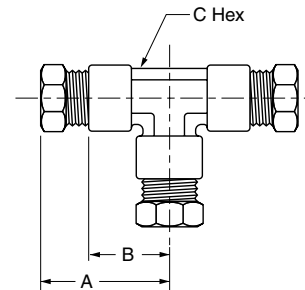

**Union Elbow 165HD**

PART NO.	TUBE SIZE	MIN. ORIFICE SIZE	A	B	C HEX
165HD-4	1/4	.187	1.084	.690	.552
165HD-6	3/8	.312	1.376	.970	.615
165HD-8	1/2	.437	1.546	1.060	.750

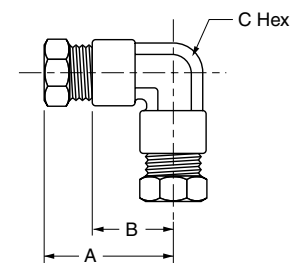

**A**

**Female Connector 66HD**

PART NO.	TUBE SIZE	PIPE THREAD	MIN. ORIFICE SIZE	A	B	C HEX
66HD-2-2	1/8	1/8	.093	1.312	1.000	.500
66HD-4-2	1/4	1/8	.187	1.406	1.000	.562
66HD-4-4	1/4	1/4	.187	1.593	1.187	.687
66HD-6-2	3/8	1/8	.312	1.531	1.125	.625
66HD-6-4	3/8	1/4	.312	1.718	1.312	.625
66HD-6-6	3/8	3/8	.312	1.750	1.343	.812

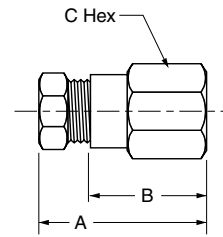

**Reducing Union 62HD**

PART NO.	TUBE SIZE	MIN. ORIFICE SIZE	A	B	C HEX
62HD-6-4	3/8 X 1/4	.187	2.000	1.187	.625
62HD-8-4	1/2 X 1/4	.187	2.125	1.281	.812
62HD-8-6	1/2 X 3/8	.312	2.656	1.406	.812

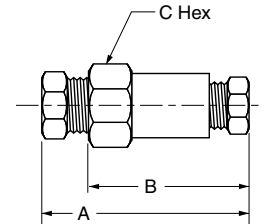

**Male Connector 68HD**

PART NO.	TUBE SIZE	PIPE THREAD	MIN. ORIFICE SIZE	A	B	C HEX
68HD-2-2	1/8	1/8	.093	1.062	.750	.437
68HD-3-2	3/16	1/8	.125	1.140	.765	.437
68HD-4-2	1/4	1/8	.187	1.343	.937	.562
68HD-4-4	1/4	1/4	.187	1.468	1.062	.562
68HD-4-6	1/4	3/8	.187	1.343	.937	.687
68HD-4-8	1/4	1/2	.187	1.531	1.125	.875
68HD-5-2	5/16	1/8	.218	1.406	1.000	.562
68HD-5-4	5/16	1/4	.218	1.500	1.093	.562
68HD-6-2	3/8	1/8	.218	1.531	1.125	.625
68HD-6-4	3/8	1/4	.312	1.656	1.250	.625
68HD-6-6	3/8	3/8	.312	1.531	1.125	.687
68HD-6-8	3/8	1/2	.312	1.531	1.125	.875
68HD-8-4	1/2	1/4	.312	1.813	1.375	.812
68HD-8-6	1/2	3/8	.406	1.750	1.312	.812
68HD-8-8	1/2	1/2	.437	1.812	1.375	.875
68HD-8-12	1/2	3/4	.437	1.625	1.187	1.062
68HD-10-6	5/8	3/8	.406	2.031	1.468	1.062
68HD-10-8	5/8	1/2	.500	2.156	1.593	1.062

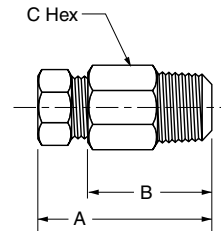

**Male Elbow 169HD**

PART NO.	TUBE SIZE	PIPE THREAD	MIN. ORIFICE SIZE	A	B	C HEX	D
169HD-2-2	1/8	1/8	.093	.975	.656	.438	.720
169HD-3-2	3/16	1/8	.125	1.056	.687	.437	.750
169HD-4-2	1/4	1/8	.187	1.084	.687	.500	.750
169HD-4-4	1/4	1/4	.187	1.144	.750	.500	.937
169HD-5-2	5/16	1/8	.218	1.144	.750	.562	.810
169HD-5-4	5/16	1/4	.250	1.206	.812	.562	1.000
169HD-6-2	3/8	1/8	.218	1.281	.875	.562	.875
169HD-6-4	3/8	1/4	.312	1.281	.875	.562	1.000
169HD-6-6	3/8	3/8	.312	1.376	.970	.615	1.031
169HD-6-8	3/8	1/2	.312	1.526	1.120	.687	1.310
169HD-8-4	1/2	1/4	.312	1.421	1.000	.678	1.062
169HD-8-6	1/2	3/8	.406	1.421	1.000	.678	1.062
169HD-8-8	1/2	1/2	.437	1.481	1.060	.740	1.420
169HD-10-6	5/8	3/8	.406	1.818	1.270	.875	1.340
169HD-10-8	5/8	1/2	.500	1.818	1.270	.875	1.480

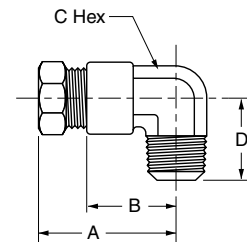



**Female Elbow 170HD**

PART NO.	TUBE SIZE	PIPE THREAD	MIN. ORIFICE SIZE	A	B	C HEX	D
170HD-2-2	1/8	1/8	.093	1.005	.690	.500	.750
170HD-4-2	1/4	1/8	.187	1.084	.687	.500	.750
170HD-4-4	1/4	1/4	.187	1.234	.843	.562	.875
170HD-6-2	3/8	1/8	.312	1.281	.875	.562	.937
170HD-6-4	3/8	1/4	.312	1.376	.970	.615	1.093
170HD-6-6	3/8	3/8	.312	1.526	1.120	.690	1.150
170HD-8-6	1/2	3/8	.437	1.481	1.062	.740	1.281

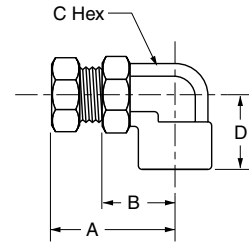

**Male Run Tee 171HD**

PART NO.	TUBE SIZE	PIPE THREAD	MIN. ORIFICE SIZE	A	B	C HEX	D
171HD-4-2	1/4	1/8	.187	1.144	.750	.500	.780
171HD-4-4	1/4	1/4	.187	1.207	.812	.500	.937
171HD-6-4	3/8	1/4	.312	1.376	.970	.562	1.000

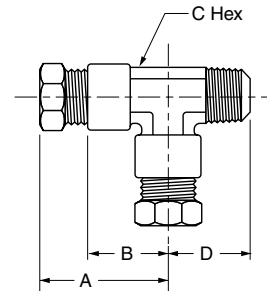

**Male Branch Tee 172HD**

PART NO.	TUBE SIZE	PIPE THREAD	MIN. ORIFICE SIZE	A	B	C HEX	D
172HD-4-2	1/4	1/8	.187	1.082	.687	.500	.780
172HD-4-4	1/4	1/4	.187	1.269	.875	.500	.937
172HD-6-6	3/8	3/8	.312	1.406	1.000	.562	1.125

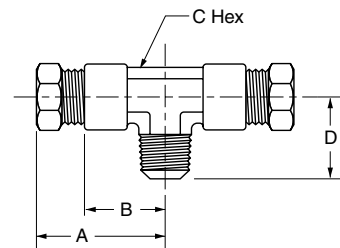

**45° Male Elbow 179HD**

PART NO.	TUBE SIZE	PIPE THREAD	MIN. ORIFICE SIZE	A	B	C HEX	D
179HD-4-2	1/4	1/8	.187	1.093	.687	.562	.750
179HD-6-4	3/8	1/4	.280	1.138	.710	.550	.850

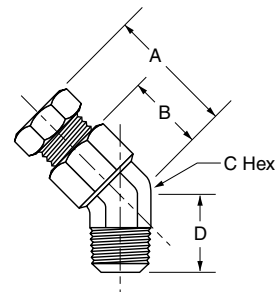



**Female Branch Tee 177HD**

PART NO.	TUBE SIZE	PIPE THREAD	MIN. ORIFICE SIZE	A	B	C HEX	D
177HD-4-2	1/4	1/8	.187	1.082	.687	.500	.750
177HD-4-4	1/4	1/4	.187	1.144	.750	.562	1.093
177HD-6-4	3/8	1/4	.312	1.376	.970	.562	1.093

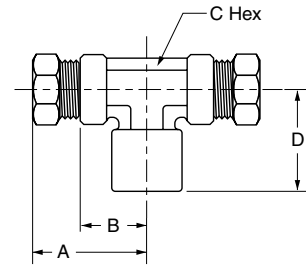

**Plug 59HD**

PART NO.	TUBE SIZE	A	C
59HD-4	1/4	.734	.437

