

1) Teach-in reference image 2) Operating voltage 3) Output 1 active 4) Output 2 active 5) Connection with PC 6) Focus



Display/Operation

Adjuster	Adjusting ring Key
Setting	Teach-in reference image Image sharpness

Electrical connection

Connection 1	M12x1-Male, 8-pole, A-coded
Connection 2	M12x1-Male, 4-pole, D-coded
Contact, surface protection	Gold plated
Short-circuit protection	yes

Electrical data

Line-induced noise	3 A
MTTF (40 °C)	127 a
No-load current I _o max. at U _e	200 mA
Operating voltage U _b	22...26 VDC
Polarity reversal protected	yes
Rated operating current I _e DC	100 mA
Rated operating voltage U _e DC	24 V
Ready delay t _v max.	10 ms
Ripple max. (% of U _e)	10 %
Voltage drop U _d max. at I _e	1.8 V

Environmental conditions

Ambient temperature	-10...55 °C
EN 60068-2-27, Shock	Half-sinus, 30 gn, 11 ms, 3x6 Half-sinus, 100 gn, 2ms, 3x8000

EN 60068-2-6, Vibration

55 Hz, amplitude 1 mm, 3x30 min
 10...2000 Hz, amplitude 1 mm,
 30 gn, 3x5 h
 IP54

Protection type IEC 60529

Functional Characteristics

Detection rate typ.	3...50 Hz
Features per inspection, number max.	255
Inspections, number max.	20

General data

Additional features	Detection of the angular position
Approval/Conformity	cULus CE
Style	Square Connection 90°

Material

Housing material	Aluminum, Die casting ABS
Housing material, surface protection	painted
Material sensing surface	PMMA
Surface protection	painted

Mechanical data

Dimension	51.5 x 70 x 40 mm
Fastening detail	Screw M4

Optical data

Field of view max.	676 x 507 mm
Field of view min.	34 x 25 mm
Focal length	6.0 mm
Image resolution	VGA 640 x 480 pixels
LED group per IEC 62471	Exempt Group
Light type	LED Red light
Sensor type Vision	CMOS image sensor black-white
Special optical feature	Incident light, can be disabled
Wave length	630 nm

Output/Interface

Duration of time function	Pulse 1...1000 ms or infinite
Input function	Program select Trigger
Interface	Ethernet 10/100 Base T
Supplementary output	Trigger output PNP
Switching output	3x PNP Normally open (NO)

Time function

On/off delay
 Single pulse

Range/Distance

Operating Distance	50...1000 mm
--------------------	--------------

Remarks

Do not press key using a pointed tool.
 Detection rate is dependent on the evaluation function.
 Do not use sensor where object is exposed to strong ambient light.
 Use of external illumination recommended for working distances greater than 300 mm .
 Only for applications per NFPA 79 (machines with a supply voltage of maximum 600 V). Appropriate connectors can be obtained from Balluff.
 Interface plug, if n.c. protect against ingress of dust, dirt and liquids. Cover cap included.
 For additional information, refer to users guide.
 Order accessories separately.
 For further information on MTTF/B10d, please refer to the MTTF / B10d Certificate.
 Specification of the MTTF value and the B10d value do not represent any binding quality and/or life expectancy guarantees.

Connector view

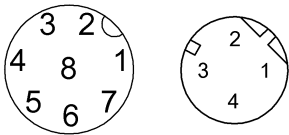

Wiring Diagram

Conn. "PWR IO"

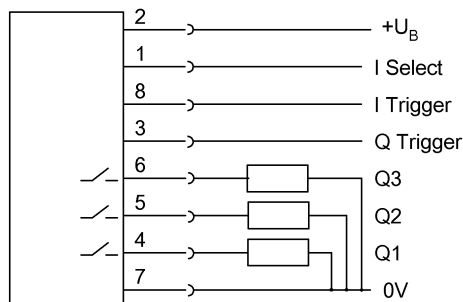

Conn. "To PC"

